

1500 - E4500 Combustion Analyzer



CE

OPERATING & MAINTENANCE MANUAL



Respect your environment: think before printing the full manual on paper

1.0	IMPORTANT INFORMATION	07
1.1	Introduction	07
1.2	Safety warnings	07
2.0	SAFETY	08
2.1	Intended use of the product	08
2.2	Improper use of the product	08
3.0	WORKING PRINCIPLE	09
3.1	Working principle	09
3.2	Measuring Sensors	09
4.0	DESCRIPTION OF THE PRODUCT	10
4.1	General Description of the Combustion Analyzer	10
4.2	General Characteristics of the Combustion Analyzer	10
4.3	Description of the Components of the Combustion Analyzer	12
4.3.1	Keypad	13
4.3.2	Display	13
4.3.3	Printer	14
4.3.4	B-Type USB connector	14
4.3.5	Serial connector	14
4.3.6	Pneumatic connector inputs / TC-K	14
5.0	MAIN CONFIGURATIONS	15
6.0	TECHNICAL SPECIFICATIONS	16
6.1	Technical specifications	16
6.2	Measurement and Accuracy Ranges	17
7.0	STARTUP	18
7.1	Preliminary operations	18
7.2	Warnings	18
7.3	Power supply of the Analyzer	18
7.3.1	Checking and replacing the batteries	18
7.3.2	Use with external power pack	19
7.4	Connection diagram	20
7.4.1	Gas Sampling Probe	21
7.4.2	Condensation trap and dust filter	21
7.4.3	Connecting the gas sampling probe and water-trap	21
7.4.4	Connecting the Tc-K probe	22
7.4.5	Combustion air temperature probe	22
7.4.6	Connection of combustion air temperature probe	22
7.4.7	Burner pressure verification probe	22
7.4.8	Ionization current measuring probe	22
7.4.9	Measurement of ambient CO	22
7.4.10	Measurement of differential pressure	22
7.4.11	Connection to PC	22
7.4.12	Connection to battery charger	22

TABLE OF CONTENTS



8.0	POWER ON - OFF	23
8.1	Starting the device	23
9.0	CONFIGURATION	24
9.1	Configuration Menu	24
9.2	Analysis Menu	25
9.2.1	Configuration=>Analysis=>Fuel	26
9.2.2	Configuration=>Analysis=>Condensation	27
9.2.3	Configuration=>Analysis=>O ₂ reference	28
9.2.4	Configuration=>Analysis=>NO _x /NO ratio	29
9.2.5	Configuration=>Analysis=>Measuring Units	30
9.2.6	Configuration=>Analysis=>Autozero	31
9.2.7	Configuration=>Analysis=>Measures list	32
9.3	Instrument Menu	34
9.3.1	Configuration=>Instrument=>Bluetooth	35
9.3.2	Configuration=>Instrument=>Time/Date	36
9.3.4	Configuration=>Instrument=>Brightness	37
9.3.5	Configuration=>Instrument=>Pump	38
9.3.6	Configuration=>Instrument=>CO dilution	39
9.3.7	Configuration=>Instrument=>Micromanometer	40
9.4	Configuration=>Operator	41
9.5	Configuration=>Alarm	43
9.6	Information Menu	44
9.6.1	Configuration=>Information=>Battery	45
9.6.2	Configuration=>Information=>Sensors	46
9.6.3	Configuration=>Information=>Info Service	47
9.6.4	Configuration=>Information=>Probes	47
9.7	Configuration=>Diagnostic	48
9.7.1	Configuration=>Diagnostic=>Sensors	49
9.7.2	Configuration=>Diagnostic=>Gas probe	50
9.7.3	Configuration=>Diagnostic=>Memory	51
9.7.4	Configuration=>Diagnostic=>Pump	52
9.7.5	Configuration=>Diagnostic=>On Site Calibration	53
9.8	Configuration=>Language	58
9.9	Configuration=>Restore	59
10.0	MEMORY	60
10.1	Memory Menu	60
10.2	Memory=>Save	62
10.3	Memory=>Average	64
10.4	Memory=>Select	65
10.4.1	Memory=>Memory recall	66
10.5	Memory=>Data logger	69
10.6	Memory=>Delete	70
10.6.1	Memory=>Delete=>Single	71
10.6.2	Memory=>Delete=>All	72
10.7	Memory=>Usage	73
11.0	PRINT	74
11.1	Print Menu	74

11.2	Print=>Report	75
11.3	Print=>Configuration	76
11.4	Print=>Test	77
11.5	Print=>Header	78
11.6	Print=>Printer	80
11.6.1	Print=>Printer=>Pairing	81
11.7	Print=>Measures list	83
12.0	MEASUREMENTS	85
12.1	Measurements Menu	85
12.2	Measurements=>Draft	87
12.3	Measurements=>Smoke	88
12.4	Measurements=>Ambient CO	89
12.5	Measurements=>Temperature	90
12.6	Measurements=>Pressure	91
12.7	Measurements=>Tightness test	92
12.7.1	Connection of the tool tightness test kit	92
12.8	Measurements=>Tightness test=>New System	93
12.8.1	Performing tightness test according to UNI 7129	95
12.9	Measurements=>Tightness test=>Existing System	98
12.9.1	Configuration of tightness test according to UNI 11137	102
12.9.2	Performing tightness test according to UNI 11137	106
12.10	Measurements=>Tightness test=>Results of the tightness test	108
13.0	COMBUSTION ANALYSIS	110
13.1	Combustion Analysis	110
13.1.1	Startup and auto-calibration of the device	110
13.1.2	Inserting the probe in the chimney	110
13.1.3	Combustion Analysis	111
13.1.4	End of Analysis	111
13.2	Combustion Analysis - Preliminary operations	112
13.3	Combustion Analysis - Manual mode	114
13.4	Combustion Analysis - UNI 10389 mode	116
13.5	Combustion Analysis - BlmSchV mode	117
13.6	Combustion Analysis - Data logger mode	118
14.0	SENSORS	119
14.1	Sensors arrangement	119
14.2	Sensor types and relevant positioning	119
14.3	Gas sensors life	120
14.4	Table of Gas sensor life	120
14.5	Expandability to 4 sensors	121
14.6	CxHy sensor for measurement of the Unburned hydrocarbons	122
14.7	Installing the CxHy sensor	122
14.8	CO ₂ sensor for Carbon Dioxide measurement in combustion processes	123
14.9	Installing the CO ₂ sensor	123
15.0	MAINTENANCE	124
15.1	Routine maintenance	124
15.2	Preventive maintenance	124
15.3	Cleaning the sample probe	124

TABLE OF CONTENTS



15.4	Maintaining the water trap / filter unit	125
15.5	Replacing the particulate filter	125
15.6	Replacing the gas sensors	125
15.8	Replacing the battery pack	129
15.9	Replacing the printer paper roll	130
16.0	TROUBLESHOOTING	131
16.1	Troubleshooting guide	131
17.0	SPARE PARTS AND TECHNICAL ASSISTANCE	133
17.1	Spare parts	133
17.2	Accessories	133
17.3	Service Centers	133
ANNEX A	- Analysis report examples	134
ANNEX B	- Coefficients of the fuels and Formulas	137
ANNEX C	- Declaration of Conformity	139

E INSTRUMENTS INTERNATIONAL LLC - ALL RIGHTS RESERVED -

Total or partial reproduction of this document by any means (including photocopying or storage on any electronic medium) and transmittal of same to third parties in any manner, even electronically, is strictly prohibited unless explicitly authorised in writing by E INSTRUMENTS INTERNATIONAL LLC.

1.0 IMPORTANT INFORMATION

1.1 Information about this manual

- This manual describes the operation and the characteristics and the maintenance of the Combustion Analyzer model E4500.
- Read this operation and maintenance manual before using the device. The operator must be familiar with the manual and follow the instructions carefully.
- This use and maintenance manual is *subject to change due to technical improvements - the manufacturer assumes no responsibility for any mistakes or misprints.*

1.2 Danger levels and other symbols

	<p>The magnets in the back of the instrument can damage credit cards, hard drives, mechanical watches, pacemakers, defibrillators and other devices proven sensitive to magnetic fields.</p> <p>It is recommended to keep the instrument at a distance of at least 10 inches away from these devices.</p>
--	---

Symbol	Meaning	Comments
--------	---------	----------



WARNING

Read information carefully and prepare safety appropriate action!

To prevent any danger from personnel or other goods. Violating the information in this manual may cause danger to personnel, the plant or the environment and may lead to liability loss.

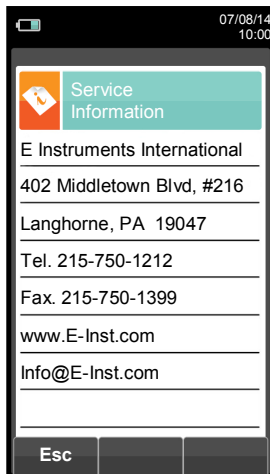

Information on LCD



Ensure correct disposal

Dispose of the battery pack at the end of its working life only at the dedicated collecting bin.

The customer takes care, on his own costs, that at the end of its working life the product is collected separately and it gets correctly recycled.



Keyboard with preformed keys with main control functions.

2.1 Intended purpose

This chapter describes the areas of application for which the E4500 is intended.

Using the E4500 in other application areas is on the risk of the operator and the manufacturer assumes no responsibility and liability for loss, damage or costs which could be a result. It is mandatory to read and pay attention to the operating/maintenance manual.

All products of the series E4500 are handheld measuring devices in professional flue gas analysis for:

- Flue gas analysis & Emissions monitoring for residential, commercial and industrial applications
- Calculating of stack heat loss and efficiency
- CO- and NO environment measurement
- Tightness test
- Store Smoke value, calculating mean value
- Measuring differential pressure
- Draft measurement
- Stack Gas velocity analysis with optional Pitot tube

2.2 Improper use of the product

The use of E4500 in application areas other than those specified in Section 2.1 "Intended use of the product" is to be considered at the operator's risk and the manufacturer assumes no responsibility for the loss damage or costs that may result. It is recommended to read and pay attention to the instructions in this use and maintenance manual.

E4500 should not be used:

- For continuous measurements > 1h without performing a fresh AutoZero calibration cycle
- As safety alarm instrument

3.0 WORKING PRINCIPLE



3.1 Working principle

The gas sample is taken in through the gas probe, by a diaphragm suction pump inside the instrument. The measuring probe has a sliding cone that allows the probe to be inserted in any stack with **the gas probe tip roughly centered in the flue.**

The gas sample is cooled, dried and cleaned of humidity and impurities/particulates by a condensate trap and filter positioned along the rubber hose that connects the probe to the analyzer.

The gas is then analyzed by electrochemical gas sensors.

The electrochemical cell guarantees high precision results in a time interval of up to about 60 minutes during which the instrument can be considered very stable. When measurement is going to take a long time, we suggest auto-zeroing the instrument again and flushing the inside of the pneumatic circuit for three minutes with clean air.

During the zero calibrating phase, the instrument aspirates clean air from the environment and detects the sensors' drifts from zero (20.9% for the O₂ cell), then compares them with the programmed values and compensates them. The pressure sensor autozero must, in all cases, be done manually prior to measuring pressure.

The values measured and calculated by the microprocessor are viewed on the LCD display which is backlit to ensure easy reading even when lighting is poor.

3.2 Measurement sensors

Oxygen (%O₂) is measured with an electrochemical cell that acts like a battery which, over time, is apt to lose sensitivity.

The toxic gases (CO, SO₂, NO, NO₂) are measured with electrochemical sensors that are not subject to natural deterioration being intrinsically lacking of oxidation processes.

The measurement sensors are electrochemical sensors made up of an anode, a cathode, and an electrolytic solution, which depends on the type of gas to be analysed. The gas penetrates the cell through a selective diffusion membrane and generates an electric current proportional to the absorbed gas. Such current is measured, digitalized, temperature-compensated, processed by the microprocessor, and displayed.

The gas shall not be at a pressure such to damage or destroy sensors. The maximum estimated allowed pressure is ± 100 mbar gage.

The response times of the measurement sensors used in the analyzer are::

- O₂ = 20 sec. at 90% of the measured value
- CO(H₂) = 50 sec. at 90% of the measured value
- CO = 50 sec. at 90% of the measured value
- NO = 40 sec. at 90% of the measured value
- NO₂ = 50 sec. at 90% of the measured value
- SO₂ = 50 sec. at 90% of the measured value

It is therefore suggested to wait 5 minutes (anyway not less than 3 minutes) in order to get reliable analysis data.

If sensors of poison gases are submitted to concentrations higher than 50% of their measurement range for more than 10 minutes continuously, they can show up to $\pm 2\%$ drift as well as a longer time to return to zero. In this case, before turning off the analyzer, it is advisable to wait for the measured value be lower than 20ppm by intaking clean air. If there is an automatic calibration solenoid, the device performs an automatic cleaning cycle and it turns off when the sensors return to a value close to zero..

The CO sensor can be protected from high gas concentrations through the dilution function which allows for a wider measurement range of the sensor without overcharging the sensor itself.

The dilution function allows the CO sensor to always be efficient and ready to respond even in the case of very high concentrations of CO.

4.1 General Description of the Combustion Analyzer

The design of the handheld combustion analyzer "E4500" is clean and ergonomic with an extremely clear and user-friendly keypad.

"E4500" immediately suggests just how even the most sophisticated engineering can give life to an incredibly comfortable and easy to use work instrument.

Devised to analyze flue gases, monitor the pollutants emitted and measure environmental parameters, "E4500" uses two electrochemical sensors that provide the oxygen and carbon monoxide values while a third cell is used to measure the pollutants NO and NO_x.

The most complete version can house a fourth sensor for measuring NO₂, SO₂ and C_xH_y. CO, NO, NO₂ and SO₂ measuring sensors are also available with a reduced measuring range, with a resolution of 0.1 ppm and better accuracy.

Two external sensors measure the environmental parameters; it is also possible to measure flue draft and carbon black and, with the measuring range of up to 200mbar, system pressure and pressure in the combustion chamber can be measured and the pressure switches checked.

Intended for eleven main types of combustibles amongst which natural gas, LPG, diesel and fuel oil, it is also possible to insert into the memory of "E4500" another 16 Fuels of which the chemical composition is known. The functions of "E4500" include the storage and the average of the data acquired, the printing (on a roll of thermal polyester paper) of the results and the possibility of connecting the device to a computer to store to data via USB connection or wireless Bluetooth.

Its internal memory is able to store 2000 complete tests and using the dedicated SW and mini-USB serial communication cable it is possible to download the data to a PC. It is also interesting to know that "E4500" is equipped with a single "Li-Ion" rechargeable battery pack used both to power the unit and for the printer: it also has a bright and wide (55 x 95 mm) TFT color display that has an excellent readability also thanks to the zoom function and the backlight.

Another characteristic that distinguishes it from other similar products in the market is the fact the power supply that comes with the product can carry out the dual function of battery charger and power supply for the instrument which means the user can carry out analyzes even if the batteries are completely drained.

Another important function is the possibility of carrying out an autozero cycle with the probe inside the stack, exploiting a sophisticated flow deviation system.

As for maintenance, it is useful to know that the sensors can be replaced by the user themselves without having to send the device to a service center because the sensors are pre-calibrated; it is however, recommended to have the entire instrument re-calibrated annually.

Also:

- **Operator interface:** user-friendly - it can be easily used without the instruction manual.
- **Wide and bright TFT color display:** great readability thanks to the Zoom function and to an efficient backlight.
- **Integrated thermal printer:** with thermal polyester paper or thermal paper you get maximum readability, durability and heat resistance.
- **One battery pack:** rechargeable for powering the instrument and the printer, indicating the charge level and is externally accessible.
- **Pneumatic input connectors (gas and pressure/draft) staying inside the profile of the instrument:** for greater resistance to external damage.
- **Pre-Calibrated sensors, directly replaceable by the user.**

4.2 General features of the Flue Gas Analyzer

The portable analyzer E4500 has been carefully designed in accordance with regulatory requirements and the specific needs of the customers.

The device contains a single board with all the basic operating circuits, pre-calibrated measuring sensors, a gas extraction pump, a solenoid valve, a dilution pump, a membrane keyboard, a TFT backlit graphic display, a high-capacity "Li-Ion" rechargeable battery pack and an integrated thermal printer. The two halves of the casing are securely fastened together with seven screws on the back of the device.

The pneumatic circuit and the measuring sensors with electronic module are positioned in the back of the casing and they are accessible, for rapid maintenance and replacement, by removing the magnet cover in the lower part of the device. The roll of paper is located at the top, above the display, and it can be replaced easily by removing the pressure-locked door. On the bottom part of the analyzer are the pneumatic connectors for gas sampling and for the measurement of the pressure/draft: the T1 connector to connect the gas probe thermocouple plug and the T2 connector to connect the combustion air probe thermocouple plug. On the right side of the device are the B-type USB connector for the connection of the external power source or of the PC and the 8-pole mini DIN connector for the serial interface or for an external probe (optional).

The user interface includes a TFT graphic display with back light always active and a membrane keyboard. The menu screens and all the operator messages can be set in the desired language.

The use of the analyzer is simplified by the symbol keys with direct access to the most important functions. Navigation through the various menu screens is easy and intuitive.

Gas extraction pump

The sample pump located inside the instrument is a DC-motor-driven diaphragm pump, powered by the instrument, and is such as to obtain optimal flow of the sampled gas being analyzed; an internal sensor that measures the flow allows to:

- Keep the flow rate of the pump constant
- Check the efficiency of the pump
- Check the degree of clogging/dirtiness of the filters

Measurement sensors

The instrument uses precalibrated gas sensors of the long-lasting FLEX-Sensor series for measuring oxygen (O₂), carbon monoxide CO (compensated in hydrogen H₂), nitrogen oxide (NO), nitrogen dioxide (NO₂) and sulphur dioxide (SO₂). An automatic internal device dilutes the concentration of CO when the instrument measures high concentrations. The diluting system also allows the CO sensor measuring range to be extended up to 100,000 ppm (for full scale 8,000 ppm sensor). The valve for the optional automatic fast autozero lets the operator turn the instrument on with the probe inserted in the flue. Up to 4 alarms can be programmed with visual and acoustic warning for the same number of measuring parameters.

The measuring sensors are the electrochemical type.

The Factory recommendation is that the instrument should be calibrated at least once a year by an authorized laboratory to issue a calibration certificate. When the sensors are drained they can be replaced easily by the user without having to send the instrument away and without complicated calibration procedures requiring sample mixtures as they are supplied already calibrated.

E Instruments does, however, certify measurement accuracy only when a calibration certificate has been issued by its own laboratory or by an authorized laboratory.

Pressure sensor

The device is internally provided with a piezoresistive differential pressure sensor to measure the draft (depression) of the chimney, according to UNI 10845, for the tightness test of the piping and possible for other measurements (gas pressure in the network, loss of pressure through filters, etc.).

Fuel types

The device is provided with the technical data of the most common types of fuels stored in its memory. By using the PC configuration program, available as an optional, it is possible to add combustibles and their coefficients in order to define up to a maximum of 16 fuels, other than the default ones.

For more details see Annex B.

Smoke measurements

It is possible to enter the smoke values measured according to the Smoke Comparison scale. The instrument will calculate the average and print the results in the analysis report.

An external smoke pump, available as an optional, must be used to effect this measurement.

Pressure decay test

The instrument can perform the tightness test of a piping according to UNI 7129 and UNI 11137: 2012.

Measuring ambient CO (available soon)

Probe for monitoring the concentration of CO and checking safe conditions in the ambient air or working environment.

Calibration certificate

The device comes with a traceable calibration certificate compliant with standard ISO/IEC 17025.

Electromagnetic compatibility

The instrument was designed to comply with Council Directive 2004/108/EC governing electromagnetic compatibility. E Instruments' declaration of conformity may be found in Annex D.

4.3 Overview of Flue Gas Analyzer Components

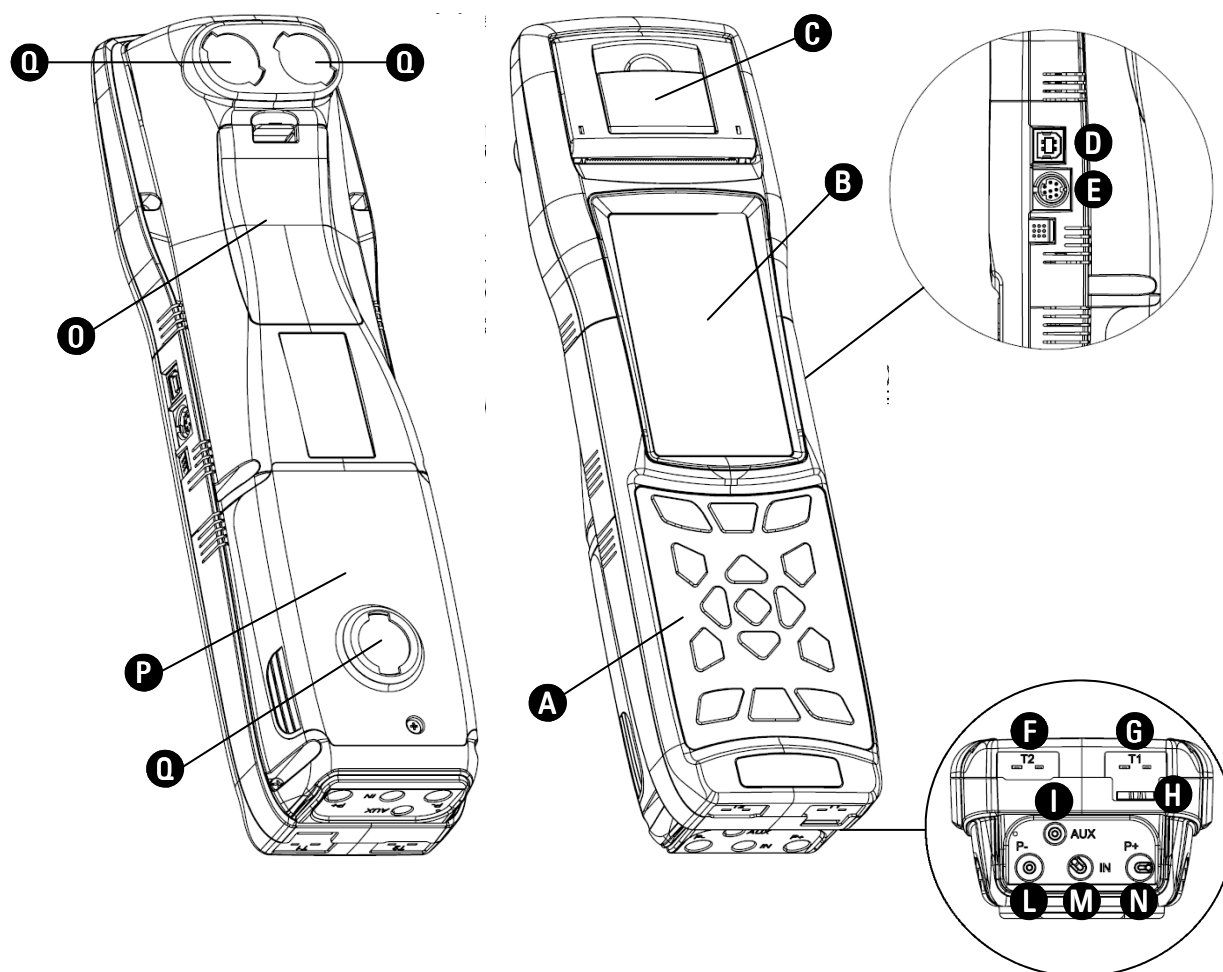

LEGEND

- A** Keypad
- B** Display
- C** Access Cover to the printer paper roll
- D** B-type USB connector to connect the device to the power source or to a PC
- E** Serial cable connector for connection with accessory probes
- F** T2 - Tc-K female connector to connect combustion air temperature probe
- G** T1 - Tc-K female connector to connect gas probe
- H** Gas Exhaust / Exit
- I** AUX connector (input for optional external probes)
- L** P- connector (negative input to measure draft)
- M** IN connector (gas exhaust probe input by means of a complete condensate separator unit)
- N** P+ connector (positive input to measure differential pressure)
- O** Battery compartment access cover
- P** Sensor compartment access cover
- Q** Magnets

4.3.1 Keypad

Adhesive polyester keypad with keys for main control functions:

KEYS	FUNCTION
	Activates the context keys shown on the display
	Access to the Memory menu
	Access to the Printing menu
	Access to the Configuration menu
	Displays the combustion analysis
	Access to the Measurements menu

KEYS	FUNCTION
	Turns the device On / Off
	Exits the current screen
	Select and/or Modify
	Confirm/Save settings

4.3.2 Display

01/01/13 00:10 — Date, time and battery status.

Combustion analysis — Selected menu.

Test 01
Test 02
Test 03
Test 04
Test 05
Test 06
Test 07

07/08/14 10:00

Combustion analysis

O₂ % 4.2
CO₂ % 9.3
Ex. Air 1.25
T flue °C 190.1
T air °C 15.4
ΔT °C 74.7
Loss tot % 8.6
Eff. tot % 91.4

Context keys. In the various menus the functions vary depending on the type of operation being carried out.

TFT 272 x 480 pixel backlit color display with 21 characters available and 8 lines. Allows the user to view the measured parameters in the most comfortable format; a Zoom function displays the measured values in magnified form.

CAUTION:

If the instrument is exposed to extremely high or extremely low temperatures, the quality of the display may be temporarily impaired. Display appearance may be improved by acting on the contrast key.

4.3.3 Printer

Thermal polyester or thermal paper. Thermal polyester cannot be altered and it is resistant to light, temperature, humidity and water.

The print menu is accessed by pressing the relative key and, besides enabling read-out printing, the menu also allows you to modify print settings and to feed the paper manually for paper roll replacement.

4.3.4 B-Type USB connector

Connector to connect the device to a personal computer or to the battery charger.

The device comes with a feeder with output 5V=, 2A to charge the internal batteries. In **D** (section 4.3) you can see the socket to connect the battery charger to the device. Once it has started charging, the display turns on and the charging state is displayed.

4.3.5 Serial connector (Mini Din 8-pole)

In **E** (section 4.3) we find the socket of the serial cable for connecting the instrument to an external probe, for example, to the draft gauge (optional), or to the ionisation current probe (optional).

4.3.6 Pneumatic connector inputs / TC-K

Pneumatic connector "A": input for the connection of the branch of the gas sampling probe with the condensation separating and anti-dust filter assembly.

Pneumatic connector "P-": negative input (P-) to be used in case of differential pressure measurements together with P+ input.

Pneumatic connector "P+": positive input (P+) to be used to measure the pressure in general and for tightness tests. It must be connected to the second branch of the gas sampling probe in order to measure the draft and analyse combustion at the same time.

WARNING: the inputs "P+" and "P-" are respectively the positive and the negative inputs of the internal differential pressure sensor, therefore they are used simultaneously to measure the differential pressure.

Female connector TC-K "T1": input for the connection of the male TC-K connector of the gas sampling probe.

Female connector TC-K "T2": input for the connection of the male TC-K connector of the combustion air temperature probe.

5.0 MAIN CONFIGURATIONS



	1500	E4500-2	E4500-3	E 4500-N	E 4500-S	E4500-C
O2 SENSOR	✓	✓	✓	✓	✓	✓
CO+H2 SENSOR	✓	✓	✓	✓	✓	✓
NO SENSOR			✓	✓	✓	✓
NO2 SENSOR				✓		
SO2 SENSOR					✓	
CxHy SENSOR						✓
NOT EXPANDABLE	✓					
POSSIBILITY OF UPGRADING TO 4 SENSOR		✓	✓			
AUTOMATIC AUTOZERO		✓	✓	✓	✓	✓
CO DILUTION		✓	✓	✓	✓	✓
BLUETOOTH		✓	✓	✓	✓	✓
TIGHTNESS TEST		✓	✓	✓	✓	✓
CALIBRATION CERTIFICATE	✓	✓	✓	✓	✓	✓
QUICK GUIDE	✓	✓	✓	✓	✓	✓
GAS SAMPLE PROBE 300mm (12") + 10' Dual Hose	✓	✓	✓	✓	✓	✓
COMBUSTION AIR TEMPERATURE PROBE	Optional	Optional	Optional	Optional	Optional	Optional
CONDENSATE TRAP	✓	✓	✓	✓	✓	✓
PRESSURE MEASURING KIT	Optional	Optional	Optional	Optional	Optional	Optional
KIT MISURA PRESSIONE DIFFERENZIALE	Optional	Optional	Optional	Optional	Optional	Optional
BATTERY CHARGER	✓	✓	✓	✓	✓	✓
US PLUG FOR BATTERY CHARGER	✓	✓	✓	✓	✓	✓
PC SOFTWARE	✓	✓	✓	✓	✓	✓
HARD CASE	✓	✓	✓	✓	✓	✓
ROLL OF PAPER PRINTER	✓	✓	✓	✓	✓	✓

1 This model identifies custom configurations different to standard ones.

6.0 TECHNICAL SPECIFICATIONS



6.1 Technical Specifications

Autozero:	Automatic autozero cycle.
Dilution (where provided):	Expansion system of the CO sensor measuring range up to 100,000ppm (10.00%) programmable as a simple protection of the CO sensor with triggering threshold programmable by the user. Preset triggering threshold at 1500 ppm.
Gas measurement sensors:	Up to 4 configurable sensors: Electrochemical and Pellistor
Self-diagnosis:	All the functions and internal functions are checked and errors signalled.
Temperature measurement:	Double K thermocouple input with mini connector (ASTM E 1684-96) to measure differential temperature (supply and return)
Measurement of ambient temp.:	Via internal sensor or T2 thermocouple input with remote probe.
Fuel Types:	12 predefined by the factory and 16 that can be programmed by the user.
Power:	Li-Ion battery pack with internal protection circuit.
Battery charger:	External 5Vdc 2A battery charger with female A-type USB connector + connection to the device with the same serial communication cable supplied.
Charging time:	5 hours to charge from 0% to 90% (6 hours for 100%). The device can also be charged by connecting it to the PC, the device must be turned off, the charging time depends on the output current from the PC and may be more than 12 hours.
Instrument working time:	12 hours of non-stop operation (excluding printing).
Printer:	Thermal integrated with easy loading paper and sensor for the presence of paper
Printer powered:	By the analyzer batteries.
Printer autonomy:	Up to 40 analysis reports with the batteries fully charged.
Internal data memory:	2000 complete data analyses, time and name of the customer can be stored.
User data:	8 programmable operator names.
Print-out heading:	4 lines x 24 characters, customizable by the user.
Display:	Graphic 272 x 480 pixels, backlit, color TFT 4.3".
Communication port:	USB with B-type connector
Bluetooth (where provided):	Communication range: <100 meters (free field) (Class 1)
Line filter:	With replaceable cartridge, 99% efficient with 20um particles.
Suction pump:	1.0 l/min heads at the flue up to 135mbar.
Measurement of flow:	Internal sensor to measure the flow of the pump.
Condensate trap:	External
Smoke Pump:	Using an external manual hand pump; it is possible to enter and print the smoke index.
Leak test:	Gas pipes tested for leaks with separate printout of the result, by means of the attachment AACKT02, according to UNI 7129 (new systems) and UNI 11137: 2012 (existing systems), with automatic calculation of pipe volume.
Condensing boiler efficiency:	Automatic recognition of the condensing boiler, with calculation and printout of efficiency (>100%)
Environmental gases:	Measurement and separate printout of the ambient CO values.
Draft test:	Draft tested as per the UNI 10845 standard. By using the internal sensor connected to the port P+, resolution 0.1 Pa , accuracy 0.5 Pa.
Operating temperature range:	-5°C to +45°C
Storage temperature range:	-20°C to +50°C
Operating humidity range:	20% to 80% RH
Protection grade:	IP42
Air pressure:	Atmospheric
Outer dimensions:	Analyzer: 3.5" x 12.2" x 2.4" (9 x 31 x 6 cm) (L x A x P) Case: 6" x 19" x 15" (15 x 48 x 38 cm) (L x A x P)
Weight:	Analyzer: ~ 2 lbs (0.9 Kg)

Compliant with the European standard EN50379-1 and EN50379-2 for the following measurements:

- O₂
- CO medium
- NO
- Temperature (flue gas)
- Temperature (supply air)
- Pressure (draft)
- Pressure (differential)

6.2 Measurement and Accuracy Ranges

MEASUREMENT	SENSOR	RANGE	RESOLUTION	ACCURACY
O ₂	Electrochemical sensor	0 .. 25.0% vol	0.1% vol	±0.2% vol
CO with H ₂ compensation	Electrochemical sensor	0 .. 8000 ppm	1 ppm	±10 ppm ±5% measured value ±10% measured value
diluted	Electrochemical sensor	10.00% vol	0.01% vol	±20% measured value
CO Low range with H ₂ compensation	Electrochemical sensor	0 .. 500 ppm	0.1 ppm	±2 ppm ±5% measured value
diluted	Electrochemical sensor	6250 ppm	10 ppm	±20% measured value
CO Mid range	Electrochemical sensor	0 .. 20000 ppm	1 ppm	±100 ppm ±5% measured value ±10% measured value
diluted	Electrochemical sensor	25% vol	0.01% vol	±20% measured value
CO Hi range	Electrochemical sensor	0 .. 10.00% vol	0.01% vol	±0.1% vol ±5% measured value
CO high immunity H ₂	Electrochemical sensor	0 .. 8000 ppm	1 ppm	±20 ppm ±5% measured value ±10% measured value
NO	Electrochemical sensor	0 .. 5000 ppm	1 ppm	±5 ppm ±5% measured value
NO Low range	Electrochemical sensor	0 .. 500 ppm	0.1 ppm	±2 ppm ±5% measured value
NO _x	Calculated			
SO ₂	Electrochemical sensor	0 .. 5000 ppm	1 ppm	±5 ppm ±5% measured value
SO ₂ Low range	Electrochemical sensor	0 .. 500 ppm	0.1 ppm	±2 ppm ±5% measured value
NO ₂	Electrochemical sensor	0 .. 1000 ppm	1 ppm	±5 ppm ±5% measured value
NO ₂ Low range	Electrochemical sensor	0 .. 500 ppm	0.1 ppm	±2 ppm ±5% measured value
C _x H _y	Pellistor sensor	0 .. 5.00% vol	0.01% vol	±0.25% vol
CO ₂	Calculated	0 .. 99.9% vol	0.1% vol	
Air temperature	TcK sensor	-20.0 .. 120.0 °C	0.1 °C	±0.5 °C
Flue gas temperature	TcK sensor	-100.0 .. 1250.0 °C	0.1 °C	±0.5 °C ±0.5% measured value
Pressure (draft & differential) UNI 10845	Piezoelectric sensor	-1000 .. 20000 Pa	±200 Pa 0.1 Pa oltre 1 Pa	±0,5 Pa ±2 Pa ±1% measured value ±1% measured value
Differential temperature	Calculated	0 .. 1250.0 °C	0.1 °C	
Air index	Calculated	0.00 .. 9.50	0.01	
Excess air	Calculated	0 .. 850 %	1 %	
Stack loss	Calculated	0.0 .. 100.0 %	0.1 %	
Efficiency	Calculated	0.0 .. 100.0 %	0.1 %	
Efficiency (condensing)	Calculated	0.0 .. 120.0 %	0.1 %	
Smoke index	External instrument	0 .. 9		

7.1 Preliminary operations

Remove the instrument from its packing and check it for damage. Make sure that the content corresponds to the items ordered. If signs of tampering or damage are noticed, notify the E INSTRUMENTS service center or distributor immediately and keep the original packing. A label on the back of the analyzer bears the serial number. This serial number should always be stated when requesting technical assistance, spare parts or clarification on the product or its use.

E Instruments maintains an updated database for each and every instrument.

Before using for the first time we recommend you charge the batteries completely.

7.2 WARNING

- Use the instrument with an ambient temperature between 23 and 113°F (-5 and +45°C).
- When it has finished being used, before turning the instrument off remove the probe and let it aspirate ambient clean air for at least 20 seconds to purge the pneumatic path from all traces of gas. Do not bypass the Post-purge.
- Do not use the instrument if the filters are clogged or damp.
- Before putting the measuring probe back in its case after use, make sure it has cooled down enough and there is no condensate in the tube. It might be necessary to periodically disconnect the filter and the condensate separator and blow compressed air inside the tube to eliminate all residue.
- Remember to have the instrument checked and calibrated once a year in order to comply with the existing standards.



IF THE INSTRUMENT HAS BEEN KEPT AT VERY LOW TEMPERATURES (BELOW OPERATING TEMPERATURES) WE SUGGEST WAITING A WHILE (1 HOUR) BEFORE SWITCHING IT ON TO HELP THE SYSTEM'S THERMAL BALANCE AND TO PREVENT CONDENSATE FORMING IN THE PNEUMATIC CIRCUIT.

7.3 Analyzer power supply

The instrument contains a high-capacity Lilon rechargeable battery.

The battery feeds the instrument, built-in printer and any other probes or remote devices that may be connected. The instrument runs for approximately 18 hours if the printer is not used. Should the battery be too low to effect the necessary measurements, the instrument can be hooked up to the mains via the power pack provided, allowing operations (and analysis) to proceed. The battery will be recharged whilst the instrument is being used. The battery charging cycle takes up to 3 hours for a complete charge and finishes automatically.

ATTENTION: If the instrument is not going to be used for a long time we suggest recharging it at least once every 2-3 months.

7.3.1 Checking and replacing the batteries

The state of the internal battery can be displayed during the auto-calibration of the device and possibly later via the information menu.

In the menu, the remaining battery power is displayed.

If battery charge appears to be low, let it discharge completely and then carry out a full 100% charge cycle by connecting the instrument to the power pack for 3 hours.

If the problem persists, replace the battery pack with a E INSTRUMENTS original or contact the SERVICE CENTER to carry out the necessary repairs.

The average life of the battery pack is 500 charging/discharging cycles. To exploit this characteristic to the full it is advisable to always use the instrument powered by the internal batteries and to charge it only when it gives the battery drained message.



THE INSTRUMENT IS SHIPPED WITH THE BATTERY HALF CHARGED SO IT IS ADVISABLE TO CHARGE IT COMPLETELY BEFORE USE, TAKING 3 HOURS.

IT IS ADVISABLE TO CHARGE THE BATTERY AT AN AMBIENT TEMPERATURE RANGING BETWEEN 50°F AND 86°F (10°C AND 30°C).

7.3.2 Use with external power pack

The instrument can work with the batteries fully discharged by connecting the external power pack provided.



THE POWER SUPPLY/BATTERY CHARGER IS A SWITCHING TYPE ONE.

THE APPLICABLE INPUT VOLTAGE RANGES BETWEEN 90Vac AND 264Vac.

INPUT FREQUENCY: 50-60Hz.

THE LOW VOLTAGE OUTPUT IS 5 VOLT WITH AN OUTPUT CURRENT GREATER THAN 1.5A.

LOW VOLTAGE POWER CONNECTOR: A-TYPE USB CONNECTOR + CONNECTION CABLE WITH B-TYPE PLUG.

7.4 Connection diagram

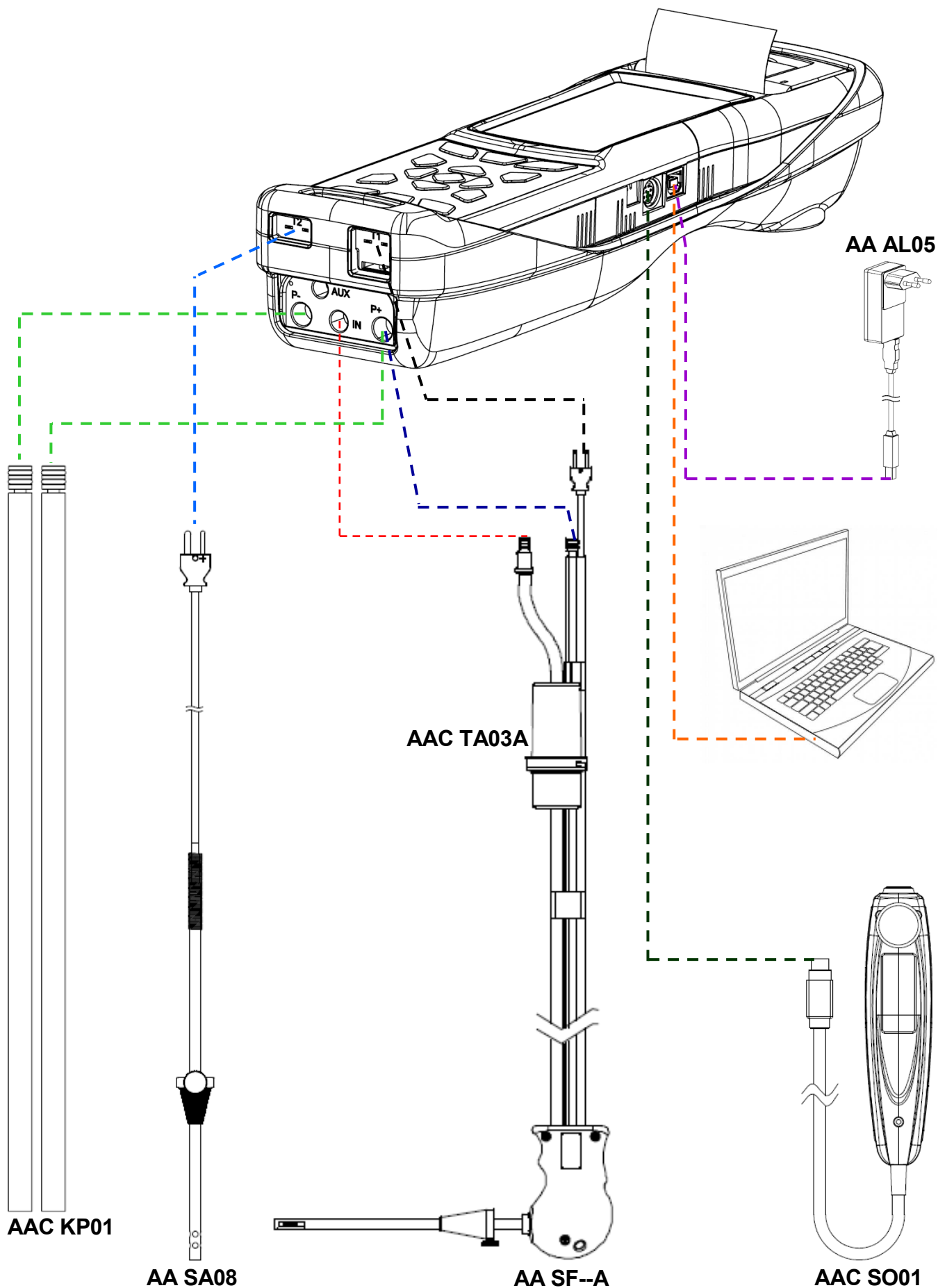

7.4.1 Gas sampling probe

The gas sampling probe is made up of an INOX steel tube with a plastic hand grip and an internal K-type thermocouple (Ni-NiCr) for measuring the gas temperature up to 1470°F (800°C). Flue gas temperature is measured by means of a thermocouple inserted in the tip of the probe.

The thermocouple is connected to the instrument via a compensated cable housed in a special seating in the rubber hose of the sample probe. The cold junction is compensated by a Pt 100 resistance thermometer which measures the temperature at the thermocouple connector. The type K thermocouple (nickel/nickel chromium) permits continuous measurements up to 800°C. If special-purpose probes are used, the instrument is able to measure temperatures as high as 2190°F (1200°C).

A Pt 100 resistance thermometer located inside the instrument measures the internal temperature; this sensor is also used to measure the ambient temperature.

Should the user want to measure the combustion air temperature directly in the intake duct, the optional remote Tc-K sensor must be used - this measurement is recommended for more precise calculation of plant efficiency.

This type of probe is available with a rigid tip with different lengths:

- 300mm: rigid tip
- 750mm: rigid tip
- 1000mm: rigid tip

7.4.2 Condensate trap and fine dust filter

The sample gas to be analyzed shall reach the measurement sensors after being properly dehumidified and purified from the residual combustion products. To this purpose, a condensate trap is used, which consists of a transparent polycarbonate cylinder placed along the rubber hose of the sampling probe. Its purpose is to decrease the air speed so that the heavier fine dust particles can precipitate and the vapor in the combustion gases can condense.

The condensate trap must be always kept in the vertical position in order to prevent condensate from touching the measurement sensors. This is also the reason why it is important to periodically drain the trap at the end of each test (see chapter 'MAINTENANCE').

A replaceable low-porosity line filter is placed after the condensate trap aimed at removing the solid particles from the gases. It is recommended to replace the filter whenever visibly dirty (see chapter 'MAINTENANCE').



KEEP THE CONDENSATE TRAP IN THE VERTICAL POSITION DURING THE ANALYSIS; A WRONG POSITION MAY CAUSE CONDENSATION IN THE INSTRUMENT AND DAMAGE THE SENSORS.

AFTER EACH ANALYSIS, CHECK FOR ANY PRESENCE OF WATER IN THE CONDENSATE COLLECTION BOWL AND REMOVE IT, IF ANY. PUT THE PROBE BACK IN THE CASE ONLY AFTER YOU HAVE ELIMINATED CONDENSATE FROM THE TUBE AND THE EXPANSION TANK (SEE CHAPTER 'MAINTENANCE').

REPLACE THE FINE DUST FILTER IF IT IS VISIBLY DIRTY OR WET (SEE CHAPTER 'MAINTENANCE'). DO NOT PERFORM ANY MEASUREMENT WHEN THE FILTER IS REMOVED OR DIRTY IN ORDER TO AVOID ANY RISK OF IRREVERSIBLE DAMAGES TO SENSORS AND ANALYZER ITSELF.

7.4.3 Connecting the gas sampling probe and water-trap assembly

As shown in section 7.4 the gas sampling probe must be connected to the device as follows:

- The polarized male connector of the thermocouple must be connected to the lower part of the device in the T1 socket. The improper insertion of the same is not possible thanks to the different lengths of the tips.
- The shorter tube of the probe must be inserted in the condensation trap with ant-dust filter (see section 7.4.2).
- The male connector of the filter assembly must be connected to the central female connector of the device marked with "IN".
- The longer tube of the probe, which ends with a male connector, must be connected to the positive pressure input of the device marked with the letter "P+".

The different diameter of the connectors does not allow improper connections: this avoids damage to the device.

7.4.4 Connecting the TcK probe

Using the same input as for the K thermocouple "T1" (the same used for gas temperature), it is possible to measure the water delivery and return temperature by connecting some **special probes**. If temperature is taken on the pipe, it is suggested to use arc probes with a suitable diameter.

7.4.5 Combustion air temperature probe (for Condensing Boilers/Furnaces)

The probe to measure the temperature of the combustion air (necessary for an exact calculation of the efficiency of the appliance) features a stainless steel tube with an adapter for wells of the diameter of 7.5 / 17 mm and K-type internal thermocouple (Ni-NiCr) to measure the temperature between -4°F and 212°F (-20°C and +100°C.) The probe comes complete with an 80" (2 m) cable with a connector for connection with the analyzer.

7.4.6 Connection of combustion air temperature probe

As shown in section 7.4 the probe must be connected to the device as follows:

- ♦ The polarized male connector of the thermocouple must be connected to the lower part of the device in the **T2** socket. The improper insertion of the same is not possible thanks to the different lengths of the tips.

7.4.7 Burner pressure verification probe (available soon)

It must be used to measure burner pressure of the gas-powered boiler so it can be regulated in real time. It is made of a silicone tube, 8x4mm and 1 meter long, complete with connector for connecting to the analyzer.

7.4.8 Ionization current measuring probe

With this special probe it is possible to measure the ionization current of a boiler and check its value depending on the boiler's technical features.

7.4.9 Measurement of ambient CO (available soon)

Probe for monitoring the concentration of CO and checking safe conditions in the boiler room.

7.4.10 Measurement of differential pressure

The device is equipped with a temperature compensated piezoresistive internal pressure sensor to measure pressures and depressions. This sensor, mounted onto the device, is of the differential type.

Thanks to the positive and negative pressure connectors, it can therefore be used to measure the differential pressure by purchasing the special KIT. The measurement range is -1000 Pa ... +20000 Pa.

7.4.11 Connection to PC

By using the USB cable supplied or via Bluetooth connection (optional) it is possible to connect the device to a personal computer after installing the dedicated software supplied.

Functions:

- See the data plate of the device
- See and/or export (in csv format, importable into excel, and/or pdf) or delete the stored analyses.
- Configure the device.

7.4.12 Connection to battery charger

Supplied with the device is a feeder with output 5V, 2A to charge the internal batteries. In section 4.3 you can see the socket for the connection of the battery charger to the device. Once it has started charging, the display turns on and the state of charge of the battery is displayed.

8.0 POWER ON - OFF

8.1 Starting the device

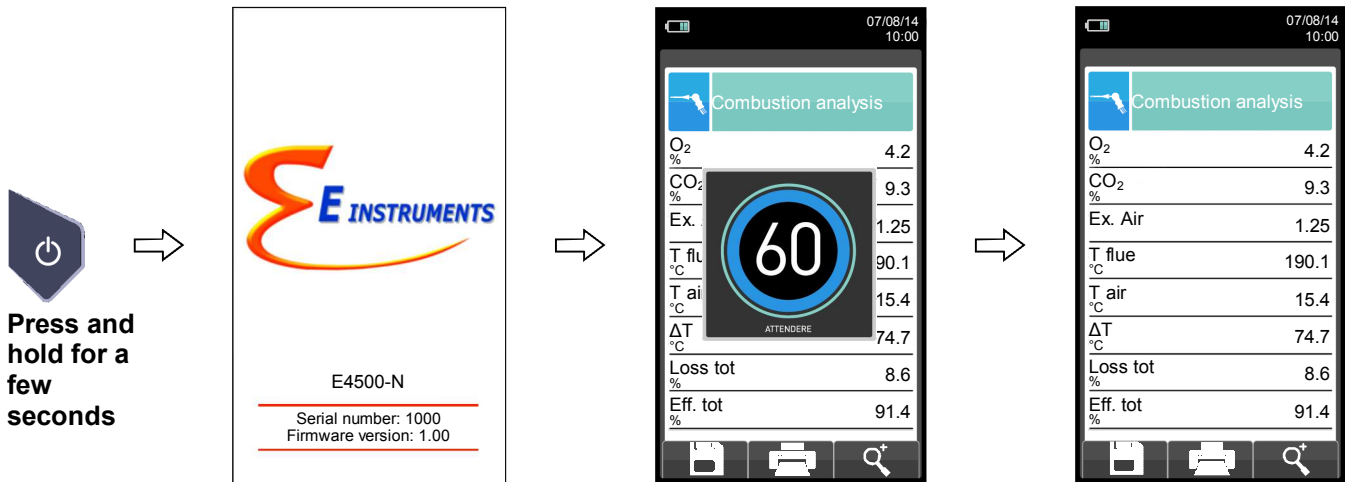

During autozero, you can only use the menus that do not require autozero.

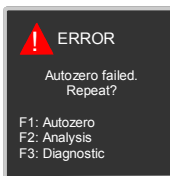

This error message is displayed if the autozero of the device is not carried out.

KEY	FUNCTION
	Activate the context keys shown on the display.
	Goes through the measurements available.
	Activates the context key located in the left side of the display.
	Returns to the previous screen.

CONTEXT KEY	FUNCTION
	Repeats autozero (is shown in the case of an error).
	The device will suspend autozero and display the screen "Combustion Analysis"; it is possible to carry out the analysis of combustion (displayed in the case of an error).
	The device displays the screen "Sensor Diagnostics" (displayed in the case of an error).
	Save analysis.
	Print the test ticket according to the settings.
	Zoom. By pressing this interactive key repeatedly, the device displays the following sequence: AAA → AAA → AAA → AAA

9.1 Configuration menu

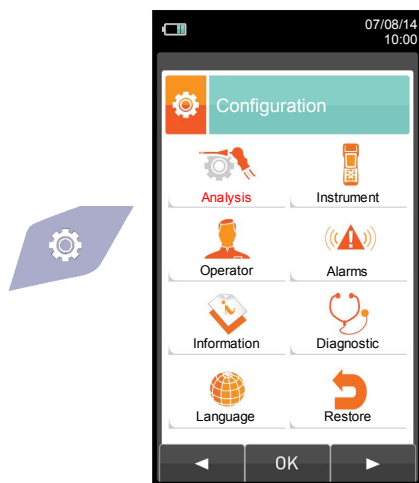

KEY	FUNCTION
	Activate the context keys shown on the display.
	Returns to the previous screen.

CONTEXT KEY	FUNCTION
	Selects the available parameters.
	Enters in the selected parameter setting.
	Selects the available parameters.

PARAMETER	FUNCTION
Analysis	Through this menu the user can configure the available parameters for a proper combustion analysis. SEE SECTION 9.2.
Instrument	This menu is used to configure the instrument's reference parameters. SEE SECTION 9.3.
Operator	In this sub menu you can enter or change the name of the operator that will carry out the analysis. Up to 8 lines are available. Also, you can select the name of the operator that will carry out the analysis and this will be printed on the analysis report. SEE SECTION 9.4.
Alarm	<p>This submenu allows the user to set and memorize 10 alarms, defining the monitored parameter for each (gas, pressure, Ta, Tf), the alarm threshold and relative unit of measurement and whether it is a low or high-level alarm. Low-level alarms are triggered when the reading drops below the defined threshold, whereas high-level alarms are triggered when the reading rises above the defined threshold. When an alarm threshold is crossed, the instrument emits an intermittent audible alarm besides activating a visible alarm wherein the background of the name of the relative reading will start flashing in the analysis screen.</p> <p>SEE SECTION 9.5.</p>
Information	This menu provides information regarding instrument status. SEE SECTION 9.6.
Diagnostic	The user, with this menu, can check any errors on the device. SEE SECTION 9.7.
Language	Set the desired language for the various menus and the test ticket. SEE SECTION 9.8.
Restore	Restore factory settings. SEE SECTION 9.9.

9.2 Configuration → Analysis



KEY	FUNCTION
	Activate the context keys shown on the display.
	Returns to the previous screen.

CONTEXT KEY	FUNCTION
	Selects the available parameters.
	Enters in the selected parameter setting.
	Selects the available parameters.

PARAMETER	DESCRIPTION
Fuel	Lets the user select the type of fuel to be used during analysis. This data can be varied either from this menu or during the analysis itself. By selecting the sub menu Fuel coefficients the user can view the characteristics of the fuels used in the calculation of performance. SEE SECTION 9.2.1.
Condensation	The burner efficiency figure when condensation takes place is influenced by atmospheric pressure and humidity of the combustion air. As the atmospheric pressure is hardly precisely known, the operator is asked to enter a related parameter, i.e. the altitude of the place above the sea level, from which the pressure is then derived once the dependency from atmospheric conditions is neglected. In calculations the value of 101325 Pa is assumed as atmospheric pressure at sea level. Further the air relative humidity input is allowed, being this calculated at the combustion air temperature as measured from the instrument; in case this value is unknown the operator is recommended to enter 50% for this value. SEE SECTION 9.2.2.
O ₂ reference	In this mode the user can set the oxygen percentage level to which pollutant emission values detected during analysis will be referenced. SEE SECTION 9.2.3.
NO _x NO _x /NO ratio	NO _x /NO: all the nitrogen oxides which are present in the flue emissions (Nitrogen oxide = NO, Nitrogen dioxide = NO ₂); total nitrogen oxides = NO _x (NO + NO ₂). In the combustion processes, it is found out that the NO ₂ percentage contained in the gas is not far from very low values (3%); hence it is possible to obtain the NO _x value by a simple calculation without using a direct measurement with a further NO ₂ sensor. The NO ₂ percentage value contained in the gas can be however set at a value other than 3% (default value). SEE SECTION 9.2.4.
Measure units	Through this submenu the user can modify the units of measurement for all the analysis parameters, depending on how they are used. SEE SECTION 9.2.5.
Autozero	In this sub menu the user can change the length of the autozero cycle of the analyzer and start it manually. SEE SECTION 9.2.6.
Measures list	In this sub menu the user can see the list of measurements that the device can perform. With the interactive keys, the user can add, delete or move a selected measurement. SEE SECTION 9.2.7.

9.2.1 Configuration → Analysis → Fuel

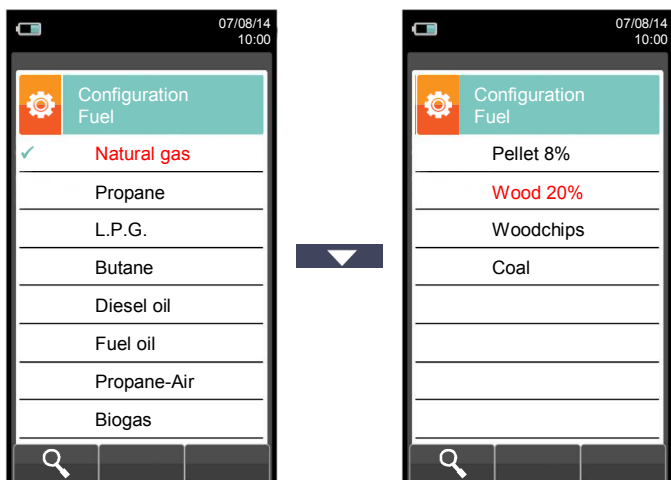

KEY	FUNCTION
	Activate the context keys shown on the display.
	The arrows select each line displayed.
	Confirms the choice of fuel to be used during the analysis.
	Returns to the previous screen.

CONTEXT KEY	FUNCTION
	Shows the details of the selected fuel (see example below).
	Returns to the previous screen.

Example:

A1	0.660	→ Coefficient for the calculation of combustion performance
B	0.0100	→ Coefficient for the calculation of combustion performance
CO ₂ t %	11.70	→ Coefficient for the calculation of combustion performance
PCI KJ/Kg	50050	→ Net calorific value of the fuel
PCS KJ/Kg	55550	→ Gross calorific value of the fuel
m air Kg/Kg	17.17	→ Specific gravity in air
m H ₂ O Kg/Kg	2.250	→ Specific gravity in water
V dry gas M ³ /Kg	11.94	→ Volumes of gas

9.2.2 Configuration → Analysis → Condensation

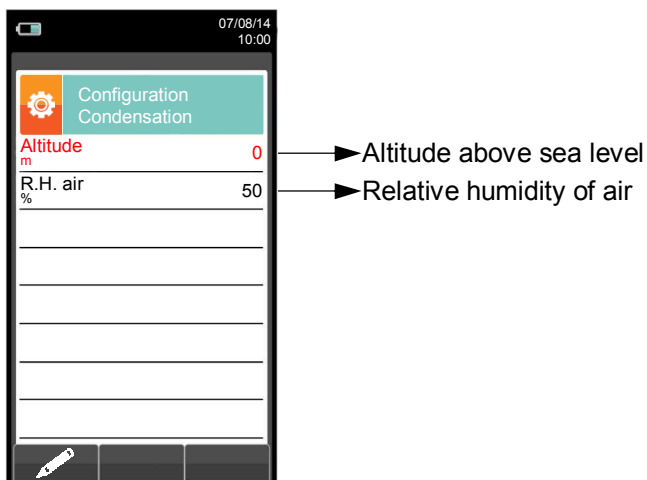

KEY	FUNCTION
	Activate the context keys shown on the display.
	The arrows select each line displayed (the selected line is red). In edit mode, it scrolls through the suggested values.
	Enters the modify mode for the selected parameter, then confirms the modification.
	When pressed in modify mode cancels the selection made, otherwise returns to the previous screen.

CONTEXT KEY	FUNCTION
	Enters the modification mode for the selected parameter.
	Confirms the modification.

Example:

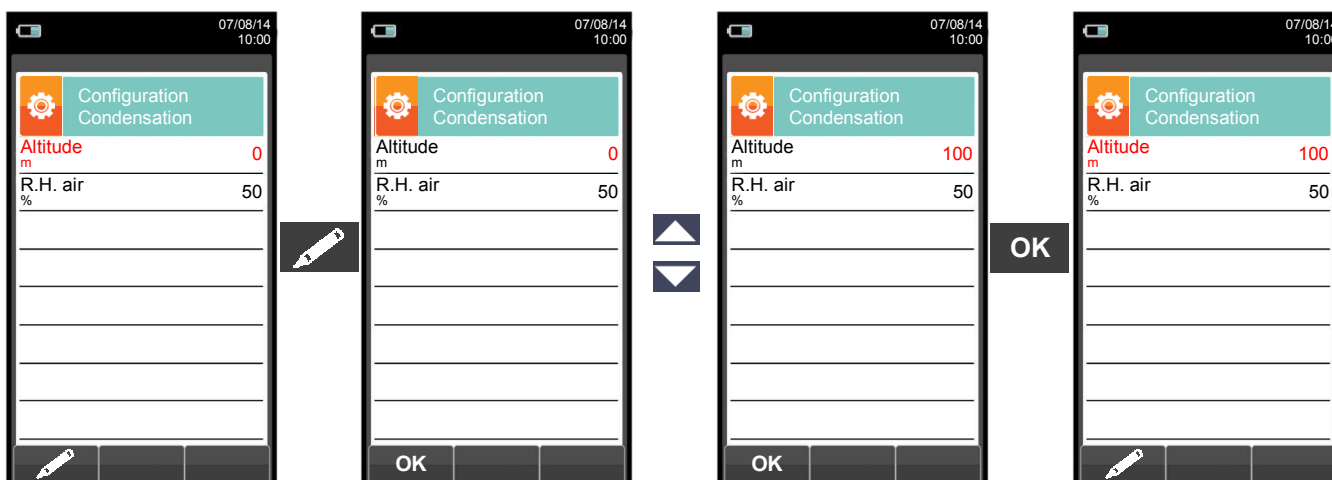

9.2.3 Configuration → Analysis → Reference O₂

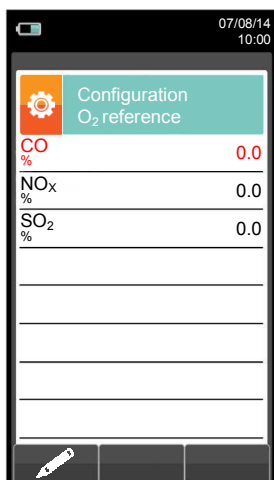

- ▶ Percentage of Oxygen in CO measurement
- ▶ Percentage of Oxygen in NO_x measurement
- ▶ Percentage of Oxygen in SO₂ measurement

KEY	FUNCTION
	Activate the context keys shown on the display.
	Keys '▲' and '▼' select any line shown on the display (the selected line is evidenced in red). When in modify mode, sets the desired value.
	Enters the modify mode for the selected parameter, then confirms the modification.
	When pressed in modify mode cancels the selection made, otherwise returns to the previous screen.

CONTEXT KEY	FUNCTION
	Enters the modify menu for the selected parameter.
	Confirms the modification.

Example:

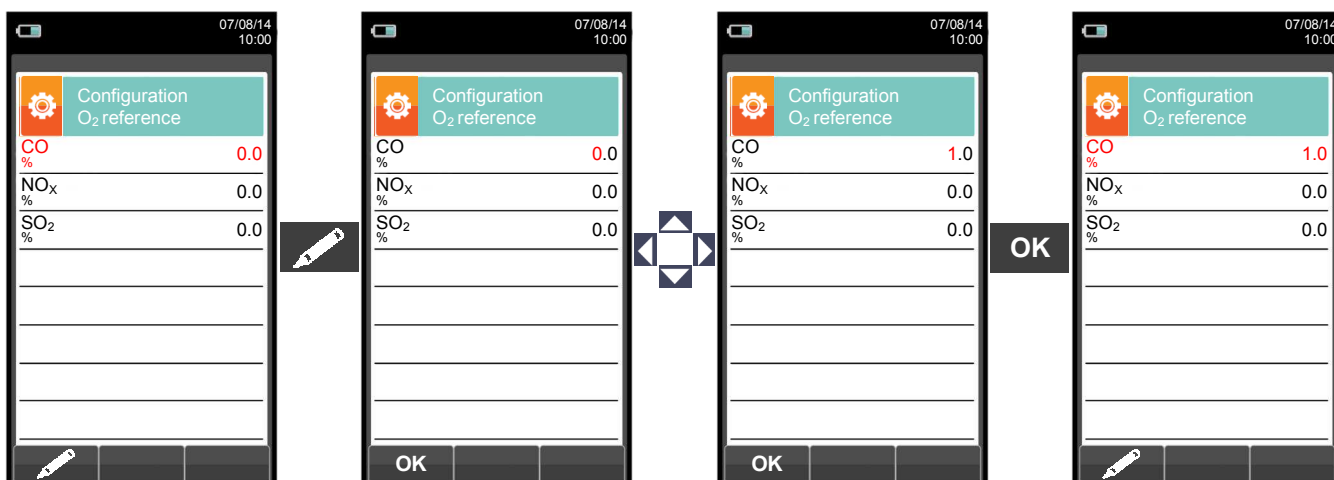

9.2.4 Configuration → Analysis → NO_x/NO ratio

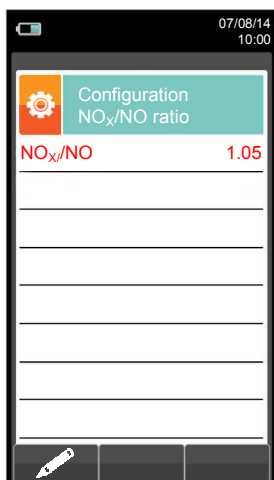

KEY	FUNCTION
	Activate the context keys shown on the display.
	When in modify mode, sets the desired value.
	Enters edit mode of the selected element and then confirms the change.
	When pressed in modify mode cancels the selection made, otherwise returns to the previous screen.

CONTEXT KEY	FUNCTION
	Enters edit mode.
	Confirms the modification.

Example:

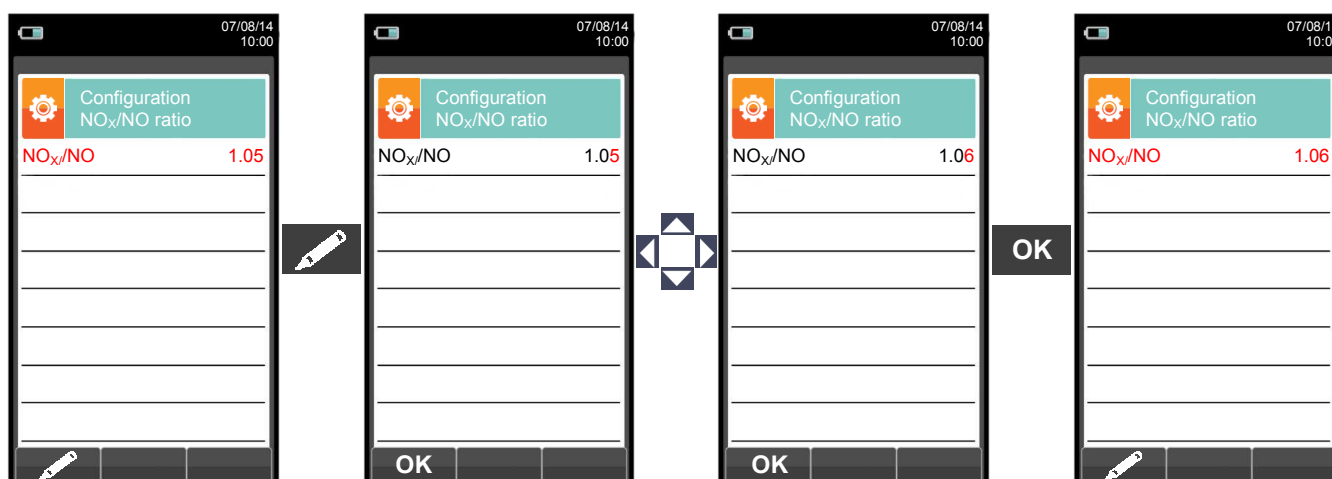

9.2.5 Configuration → Analysis → Measurement units

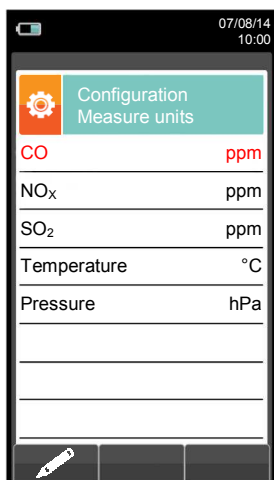

- ▶ Measurement unit can be set as: ppm - mg/m³ - mg/kWh - g/GJ - g/m³ - g/kWh - %
- ▶ Measurement unit can be set as: ppm - mg/m³ - mg/kWh - g/GJ - g/m³ - g/kWh - %
- ▶ Measurement unit can be set as: ppm - mg/m³ - mg/kWh - g/GJ - g/m³ - g/kWh - %
- ▶ Measurement unit can be set as: °C - °F
- ▶ Measurement unit can be set as: hPa - Pa - mbar - mmH₂O - mmHg - inH₂O - psi

KEY	FUNCTION
	Activate the context keys shown on the display.
	Keys '▲' and '▼' select any line shown on the display (the selected line is evidenced in red). When in modify mode, sets the desired value.
	Enters edit mode of the selected element and then confirms the change.
	When pressed in modify mode cancels the selection made, otherwise returns to the previous screen.

CONTEXT KEY	FUNCTION
	Enters the modification mode for the selected parameter.
	Confirms the modification.

Example:

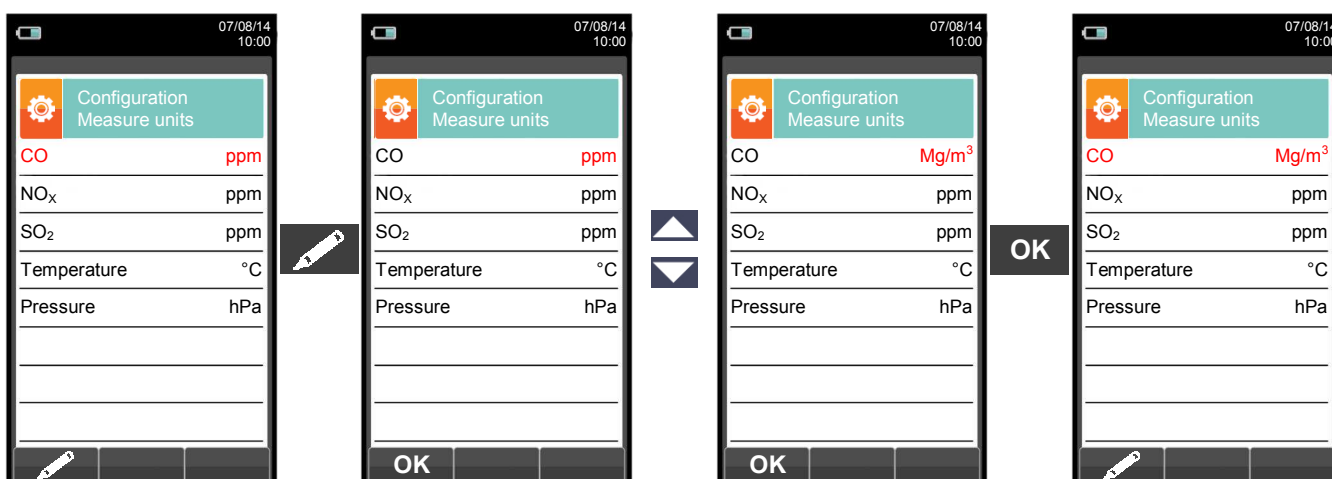

9.2.6 Configuration → Analysis → Autozero

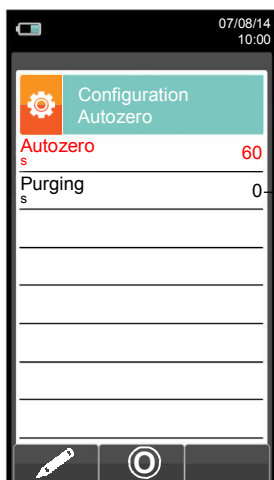

► Duration of autozero, expressed in seconds.

► Duration of the cleaning cycle, expressed in seconds.

KEY	FUNCTION
	Activate the context keys shown on the display.
	When in modify mode, sets the desired value.
	Enters edit mode of the selected element and then confirms the change.
	When pressed in modify mode cancels the selection made, otherwise returns to the previous screen.

CONTEXT KEY	FUNCTION
	Enters the modify menu for the selected parameter.
	Confirms the modification.
	Starts autozero for the selected duration.

Example:

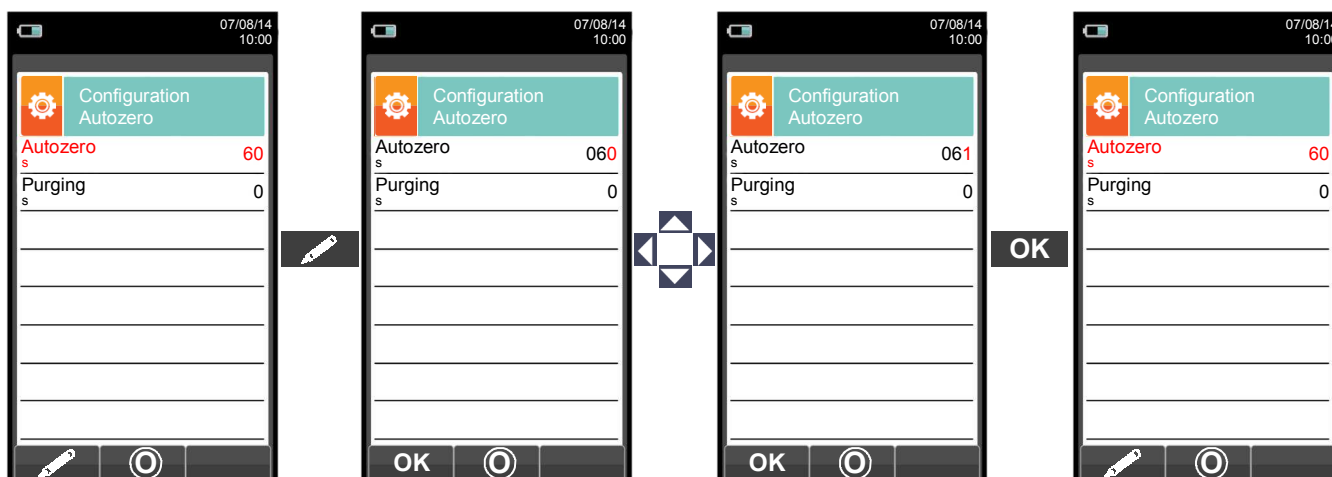

9.2.7 Configuration→Analysis→Measures list

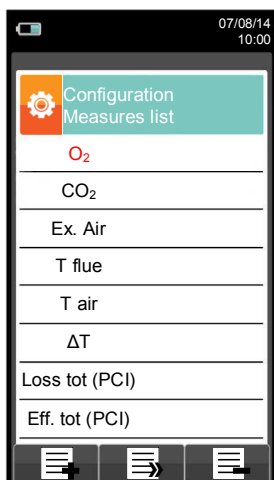

KEY	FUNCTION
	Activate the context keys shown on the display.
	Select each line displayed (the line selected is red). In edit mode, it sets the desired value.
	When pressed in modify mode cancels the selection made, otherwise returns to the previous screen.

CONTEXT KEY	FUNCTION
	Adds a line to the list of available measurements.
	Activates the movement of a measurement from its current position.
	Deletes a measurement from the list of available measurements.
	After the activation of the function ' ': It scrolls through the available measurements. After the activation of the function ' ': It moves the element from its current position.
	Confirms the operation.
	Cancels the operation.

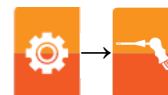

Example:

1. Add a measurement to the list - example

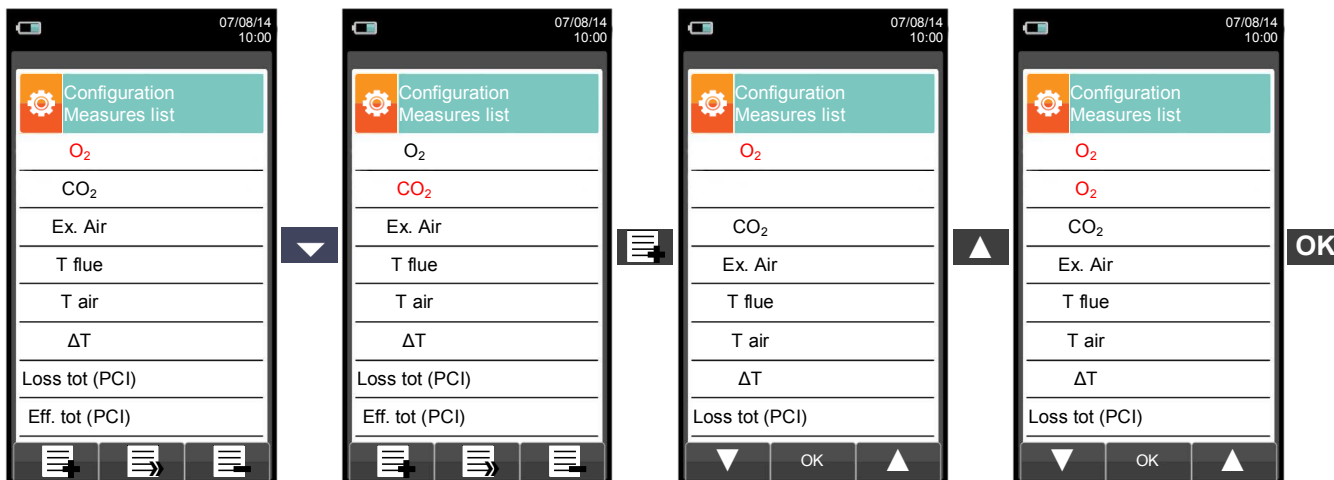

2. Change the position of a measurement - example

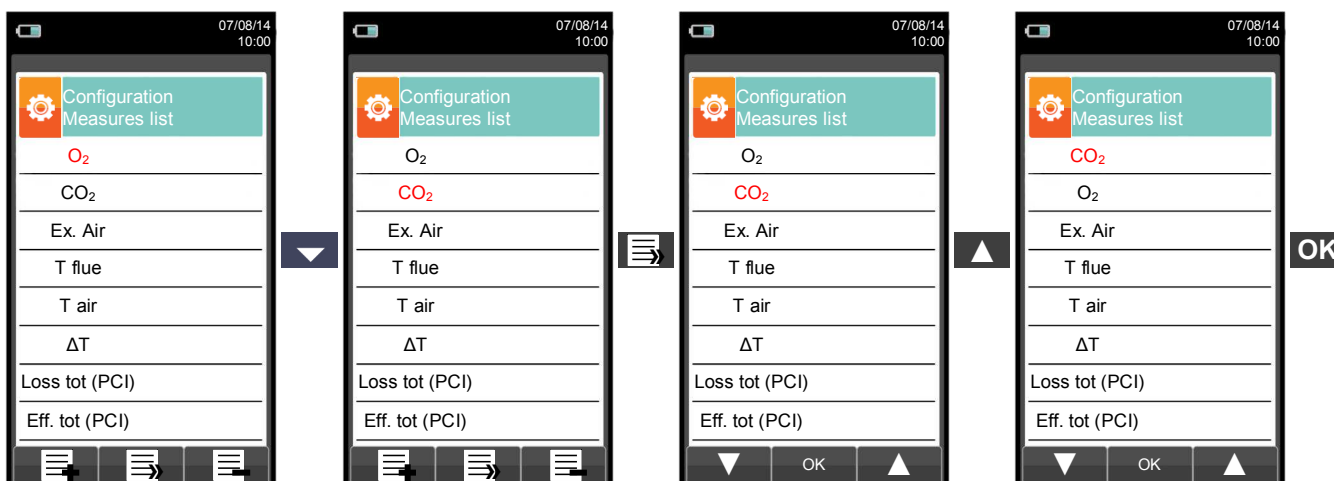

3. Delete a measurement from the list - example

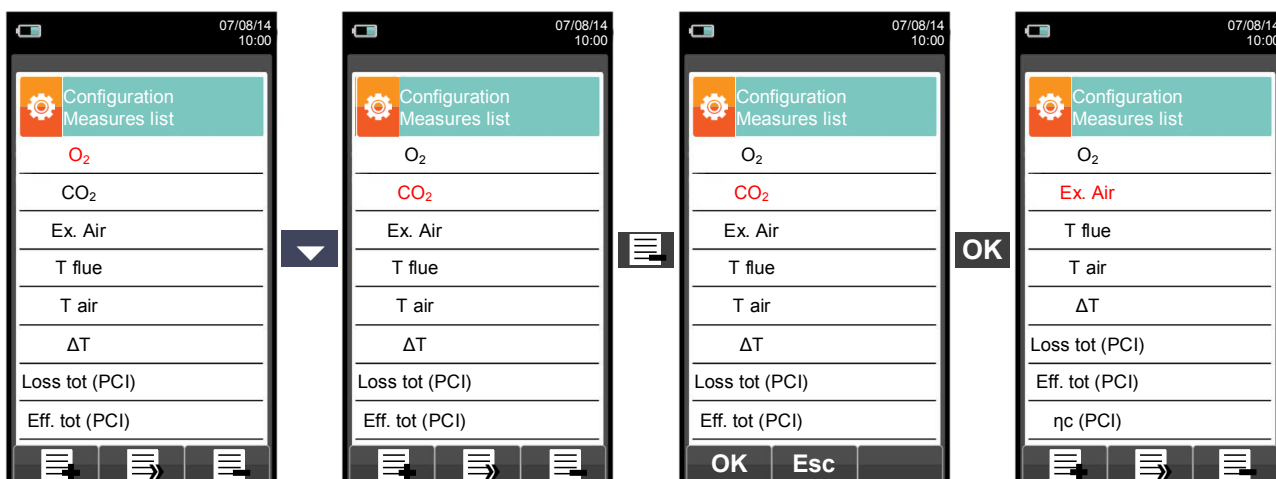

9.3 Configuration→Instrument

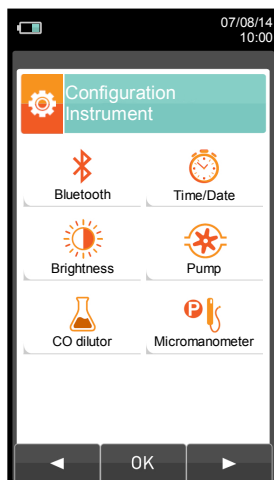

KEY	FUNCTION
	Activate the context keys shown on the display.
	Returns to the previous screen.

CONTEXT KEY	FUNCTION
	Selects the available parameters.
	Enters in the selected parameter setting.
	Selects the available parameters.

PARAMETER	DESCRIPTION
 Bluetooth	<p>Through this sub menu the user can turn on and off the instrument Bluetooth wireless communication with a PC or PDA.</p> <div style="border: 1px solid black; padding: 5px;"> WHEN THE INSTRUMENT BLUETOOTH INTERFACE IS TURNED ON, THE BATTERY LIFE IS REDUCED DOWN TO 10 HOURS. </div> <p>SEE SECTION 9.3.1.</p>
 Time/Date	<p>This allows the current time and date to be set. The user can select the date and hour format either in USA (American) or EU (European) mode.</p> <p>SEE SECTION 9.3.2.</p>
 Brightness	<p>The display contrast may be increased or decreased by acting on cursor keys. This operation may be performed even when the introductory screen is active.</p> <p>SEE SECTION 9.3.3.</p>
 Pump	<p>In this sub menu the user can turn the gas suction pump off or back on. Also, if the pump is on, the user can view the flow of the pump in litres per minute.</p> <p>It is not possible to turn off the pump during an autozero cycle.</p> <p>SEE SECTION 9.3.4.</p>
 CO dilutor	<p>The CO sensor is protected by a pump which, in case of need, can inject clean air in the gas path in order to dilute the gas concentration measured by the sensor. This function can be either triggered by the overcoming of a CO concentration threshold which can be set by the user or, in case it is known that the flue gases contain high CO concentration, kept enabled any time, independently of CO concentration.</p> <div style="border: 1px solid black; padding: 5px;"> CO Auto-Dilution feature must only be considered as a means of protection for CO sensor, as its activation widens both the accuracy and resolution of the CO measurement. </div> <p>SEE SECTION 9.3.5.</p>
 Micromanometer	<p>Allows to configure the micromanometer input (optional) as P+ or P- port. In case P- is selected, the sign of pressure is inverted.</p> <p>SEE SECTION 9.3.6.</p>

9.3.1 Configuration → Instrument → Bluetooth

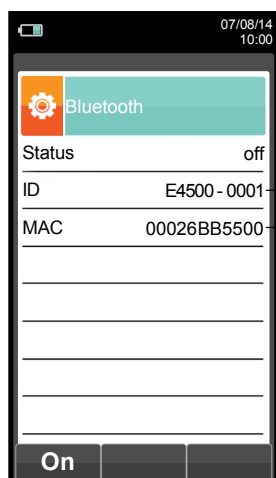
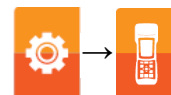

► Bluetooth enabling / disabling
 ► Instrument name
 ► MAC address detected

KEY	FUNCTION
	Activate the context keys shown on the display.
	Also activates the context key shown on the display.
	Returns to the previous screen.

CONTEXT KEY	FUNCTION
	Turns on Bluetooth communication.
	Turns off Bluetooth communication.

9.3.2 Configuration→Instrument→Time/Date

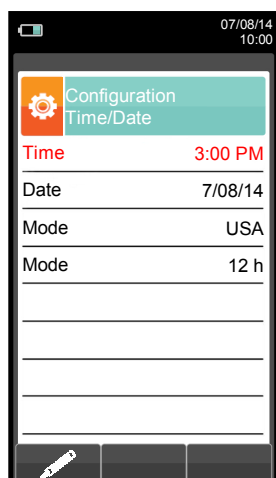
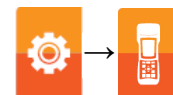

- ▶ Time, in the chosen format
- ▶ Date, in the chosen format
- ▶ Date format: USA (American) or EU (European)
- ▶ Time format: 12h or 24h

KEY	FUNCTION
	Activate the context keys shown on the display.
	When in modify mode, sets the desired value.
	Enters edit mode of the selected element and then confirms the change.
	When pressed in modify mode cancels the selection made, otherwise returns to the previous screen.

CONTEXT KEY	FUNCTION
	Enters edit mode of the selected parameter.
	Confirms the modification.

9.3.3 Configuration→Instrument→Brightness



KEY	FUNCTION
	Activate the context keys shown on the display.
	Increases or decreases the brightness of the display.
	Confirms the modification.
	When pressed in modify mode cancels the selection made, otherwise returns to the previous screen.

CONTEXT KEY	FUNCTION
	Decreases the brightness of the display.
	Confirms the setting.
	Increases the brightness of the display.

9.3.4 Configuration→Instrument→Pump

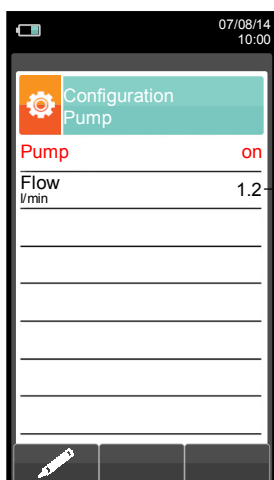

Displays the flow of the pump, expressed in litres per minute.

KEY	FUNCTION
	Activate the context keys shown on the display.
	When in modify mode, sets the desired value.
	Enters edit mode of the selected element and then confirms the change.
	When pressed in modify mode cancels the selection made, otherwise returns to the previous screen.

CONTEXT KEY	FUNCTION
	Enters edit mode: it is possible to turn the gas suction pump on or off.
	Confirms the modification.

9.3.5 Configuration→Instrument→CO dilutor

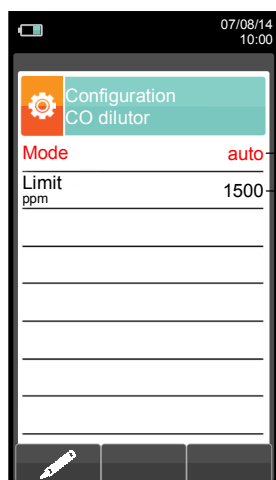
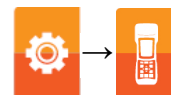

- ▶ Available settings: auto, on or off
- ▶ Threshold that activates the dilution pump (available only if the "Mode" parameter is set o "auto".

KEY	FUNCTION
	Activate the context keys shown on the display.
	Select each line displayed (the line selected is red). In edit mode, it sets the desired value.
	Enters edit mode of the selected element and then confirms the change.
	When pressed in modify mode cancels the selection made, otherwise returns to the previous screen.

CONTEXT KEY	FUNCTION
	Enters edit mode of the selected parameter.
	Confirms the modification.

9.3.6 Configuration→Instrument→Micromanometer

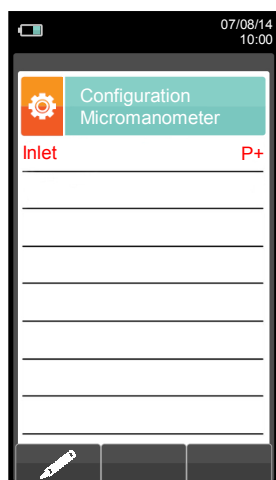
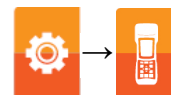

→ Sets the input used for the test: P+ o P-

KEY	FUNCTION
	Activate the context keys shown on the display.
	In edit mode, it sets the desired input.
	Enters edit mode of the selected element and then confirms the change.
	When pressed in modify mode cancels the selection made, otherwise returns to the previous screen.

CONTEXT KEY	FUNCTION
	Enters edit mode of the selected parameter.
	Confirms the modification.

9.4 Configuration→Operator

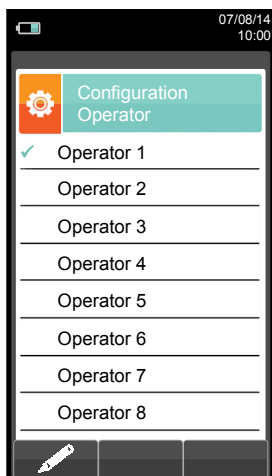

KEY	FUNCTION
	Activate the context keys shown on the display.
	In "edit text": Moves the cursor on the box corresponding to the letter or number required to form the word.
	In "Operator Configuration": Scrolls through the available operators.
	In "edit text": Confirms text input. In "Operator Configuration": selects the operator who will carry out the analysis; the operator is highlighted with the symbol "✓".
	Returns to the previous screen. In "edit text" back to the previous screen without saving any changes made.

CONTEXT KEY	FUNCTION
	Enters edit mode of the selected line: it is possible to enter the name of the operator (24 characters available).
	Confirms the selected letter or digit.
	Cancel the letter or digit before the cursor.
	Cycles through uppercase, lowercase, symbols and special characters.



Example:

1. Edit text

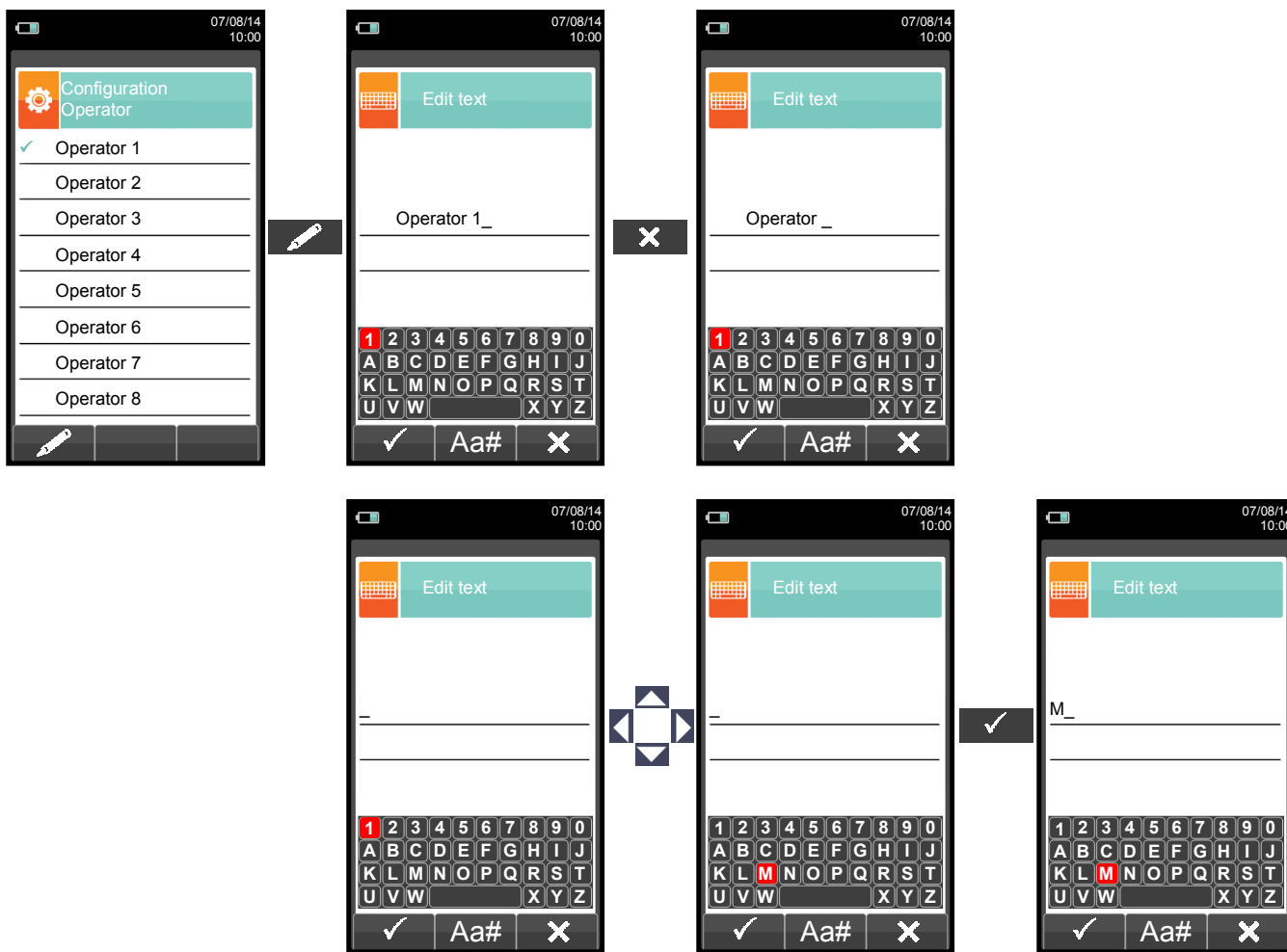

2. Select the operator who will carry out the analysis

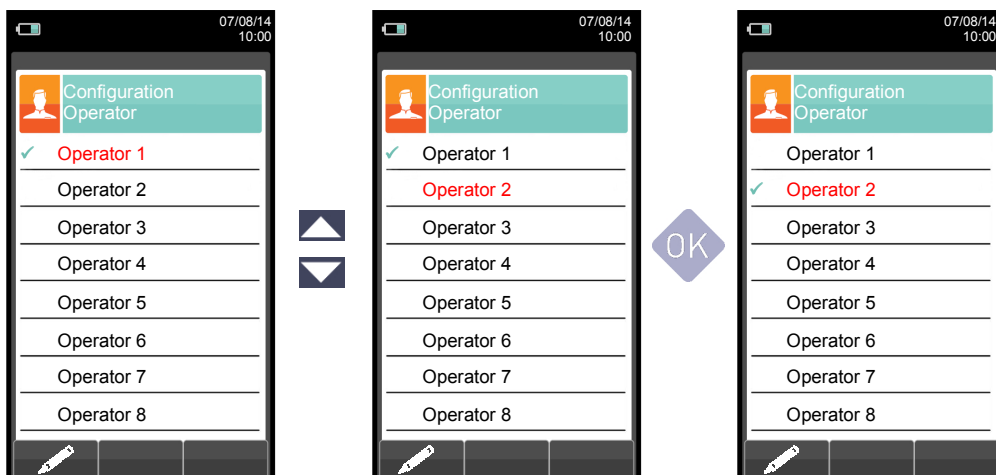

9.5 Configuration → Alarm

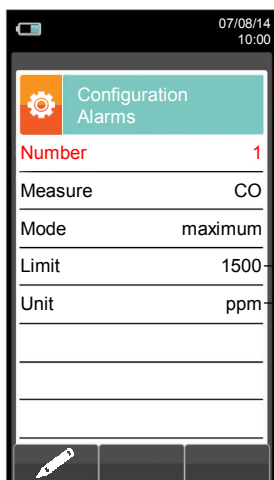

- ▶ Number of the alarm set
- ▶ Monitored parameter: O₂ - CO - NO - NO₂ - P diff - Plow - P ext - T1 - T2
- ▶ Type of alarm set: Maximum, Minimum, Off
- ▶ Threshold setting for the alarm: ±999999.999
- ▶ Measurement unit for the threshold set: ppm, mg/m³, mg/kWh, g/GJ, g/m³, g/kWh, %

KEY	FUNCTION
	Activate the context keys shown on the display.
	Keys '▲' and '▼' select any line shown on the display (the selected line is evidenced in red). When in modify mode, sets the desired value.
	Enters the modify mode for the selected parameter, then confirms the modification.
	When pressed in modify mode cancels the selection made, otherwise returns to the previous screen.

CONTEXT KEY	FUNCTION
	Enters the modify menu for the selected parameter.
	Confirms the modification.

9.6 Configuration→Information

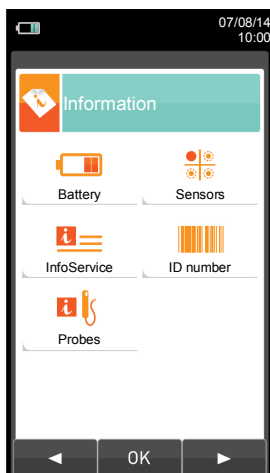

KEY	FUNCTION
	Activate the context keys shown on the display.
	Returns to the previous screen.

CONTEXT KEY	FUNCTION
	Selects the available parameters.
	Enters in the selected parameter setting.
	Selects the available parameters.

PARAMETER	DESCRIPTION
 Battery	Displays the state of charge of the internal battery. Displays the state of charge of the battery in percentage from 0 to 100%, both in text and graphically. SEE SECTION 9.6.1.
 Sensors	It allows to check which sensors are installed on the instrument, and in which position they are installed. The instrument automatically detects whether a sensor has been either added or removed. The screen page allows whether to accept the new configuration or ignore the change performed. SEE SECTION 9.6.2.
 Infoservice	This submenu contains details regarding the E Instruments' Service Center to be contacted in the event of instrument fault or ordinary maintenance. The instrument model, serial number and firmware version are also displayed, thus allowing for a quick product identification. SEE SECTION 9.6.3.
 ID number	Not available.
 Probes	Displays useful information on the probe connected to the serial cable connector visible in E in section 4.3 (Description of the Components of the Combustion Analyzer). SEE SECTION 9.6.6.

9.6.1 Configuration→Information→Battery

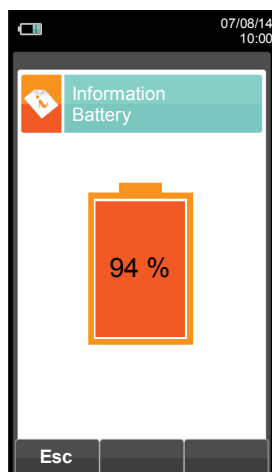

KEY	FUNCTION
	Activate the context keys shown on the display.
	Returns to the previous screen.

CONTEXT KEY	FUNCTION
	Returns to the previous screen.

9.6.2 Configuration→Information→Sensor

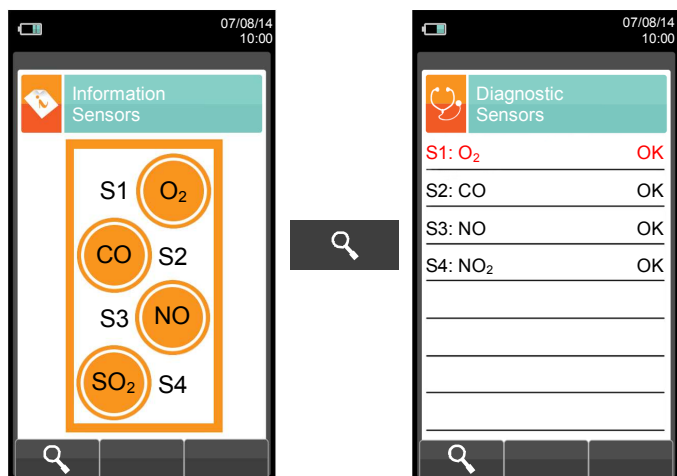

For further information, see section 9.7.1.

KEY	FUNCTION
	Activate the context keys shown on the display.
	Returns to the previous screen.

CONTEXT KEY	FUNCTION
	Displays the details of the main features of the sensors installed.
	Returns to the previous screen.

This screen displays, for each position, the following messages (example referring to the sensor in position S3):

MESSAGE	DESCRIPTION
	Sensor configured OK (normal operation).
Flashing orange circle without writing indicating the gas detected	Sensor is not communicating or has been removed.
Flashing orange circle with writing indicating the gas detected	New sensor detected.
Flashing orange circle with writing indicating the new gas detected	Detected sensor different from the one previously installed.
	Detected sensor in wrong position.

Error messages displayed:

MESSAGE	DESCRIPTION
Err cal	Calibration error.
Err data	Sensor not recognized.
No cal	Sensor not calibrated.

9.6.3 Configuration→Information→InfoService

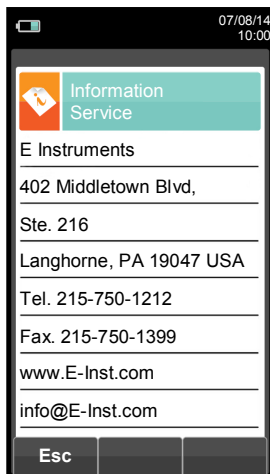

KEY	FUNCTION
	Activate the context keys shown on the display.
	Returns to the previous screen.

CONTEXT KEY	FUNCTION
	Returns to the previous screen.

9.6.4 Configuration→Information→Probe

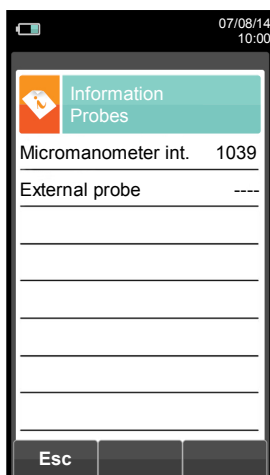
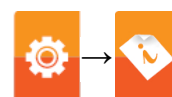

KEY	FUNCTION
	Activate the context keys shown on the display.
	Returns to the previous screen.

CONTEXT KEY	FUNCTION
	Returns to the previous screen.

9.7 Configuration → Diagnostic

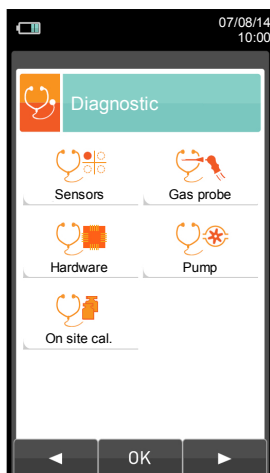

KEY	FUNCTION
	Activate the context keys shown on the display.
	Returns to the previous screen.

CONTEXT KEY	FUNCTION
	Selects the available parameters.
	Enters in the selected parameter setting.
	Selects the available parameters.

PARAMETER	DESCRIPTION
<p>Sensors</p>	<p>Displays information on the state and calibration of the electrochemical sensors:</p> <p>Ok No problem detected absent The sensor was not detected err data Memory data error of the sensor unknown It is necessary to update the FW of the device err pos The sensor has been installed in the wrong position err cal Calibration error (sensor not calibrated) err curr Currents outside the range err cfg Do not use this sensor as it has not been accepted on the screen "types of sensors".</p> <p>Also, from this screen the user can access the identification data of the sensor: type, serial number, date of manufacture and calibration. There are also the measured currents; in this way it is possible to perform a quick diagnosis in the event of a malfunction. SEE SECTION 9.7.1.</p>
<p>Gas probe</p>	<p>Tests the tightness of the gas probe pneumatic path. SEE SECTION 9.7.2.</p>
<p>Hardware</p>	<p>When instrument powers on, the firmware performs a full check on the physical Eff. tot of all types of HW memories installed on the instrument, as well as on the integrity of the data stored into them. Any issue is evidenced in the screen 'Memories Diagnostics'. Should this happen it is advisable to turn the instrument off and then on again. In case the problem is permanent or frequently recurring, the user should contact the Service Center reporting the error code shown by the instrument. SEE SECTION 9.7.3.</p>
<p>Pump</p>	<p>In this submenu the user can temporarily turn the gas suction pump on or off. Also, it is possible to view the actual flow rate of the pump in litres per minute. It will not be possible to turn off the pump during an autozero cycle. SEE SECTION 9.7.4.</p>
<p>On site cal.</p>	<p>It is possible to make a recalibration of the instrument's gas sensors with suitable known concentration gas cylinders. Recalibration of Oxygen (O₂) sensor is not available since it is already recalibrated during every autozero sequence. The access to the sensor recalibration is password protected, the password is ' 1111 '. SEE SECTION 9.7.5.</p>

9.7.1 Configuration → Diagnostic → Sensors

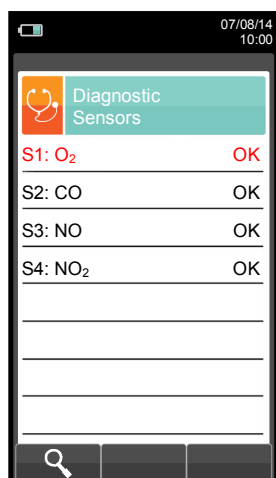

KEY	FUNCTION
	Activate the context keys shown on the display.
	Selects the fuel.
	Activates the context keys located in the left side of the display.
	Returns to the previous screen.

CONTEXT KEY	FUNCTION
	Displays the details of the selected sensor (see example below).
	Returns to the previous screen.

Example:

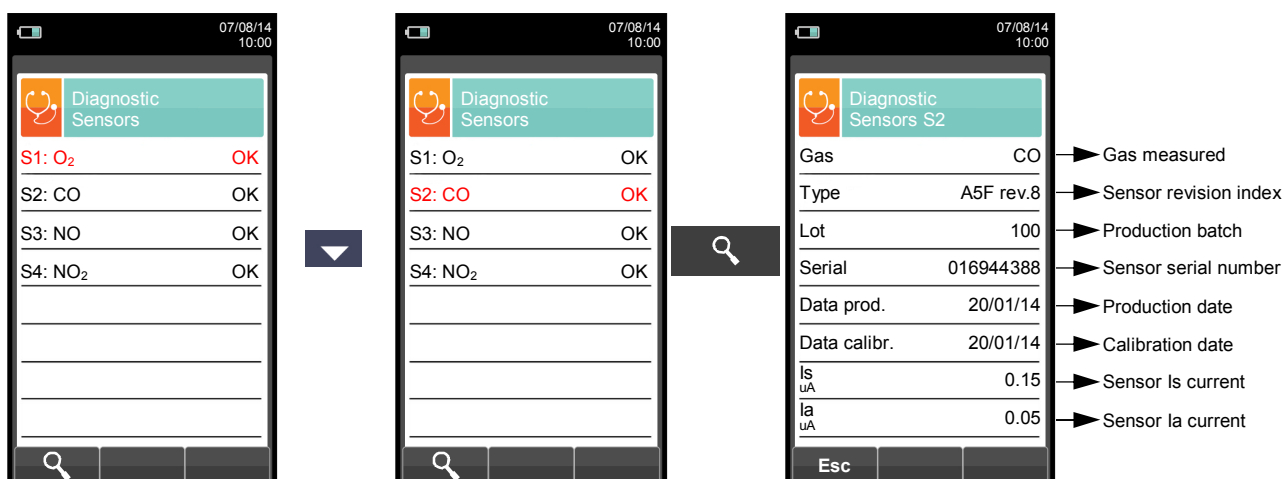

9.7.2 Configuration → Diagnostic → Gas probe

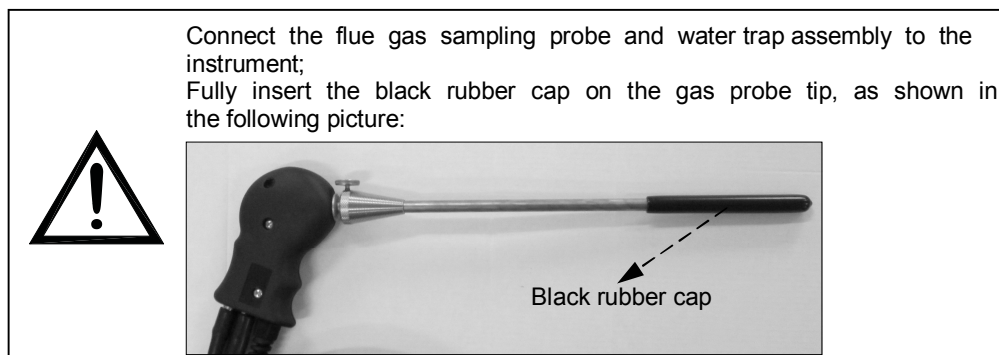
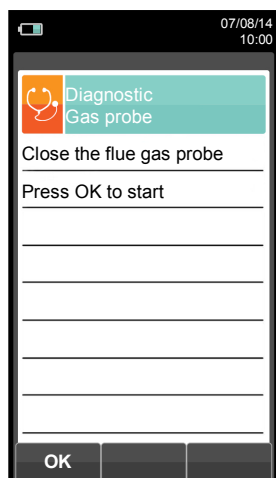

KEY	FUNCTION
	Activate the context keys shown on the display.
	Activates the context key located in the left side of the display.
	Returns to the previous screen.

CONTEXT KEY	FUNCTION
	Starts the test to check the tightness of the gas sampling probe.
	Starts the test of the gas sampling probe.

Tightness test of the probe.

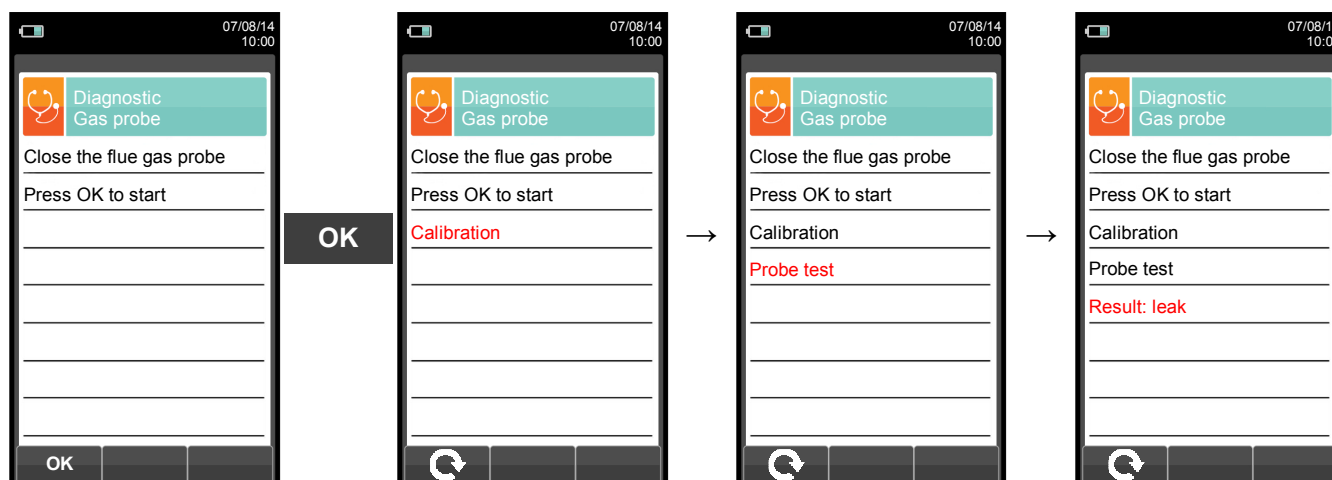

Results:

Tightness: The system is OK

Error: Make sure that the probe is connected to the input P-, check the seals of the pneumatic connections and/or the seal of the condensation trap and check that the test cap is correctly inserted on the tip of the probe. **WARNING: a damaged probe tip may impair the test.**

9.7.3 Configuration → Diagnostic → Hardware



- ▶ State of memory.
- ▶ State of calibration.
- ▶ Version of CPU board
- ▶ Version of motherboard

KEY	FUNCTION
	Activate the context keys shown on the display.
	Returns to the previous screen.

CONTEXT KEY	FUNCTION
	Returns to the previous screen.

9.7.4 Configuration→Diagnostic→Pump

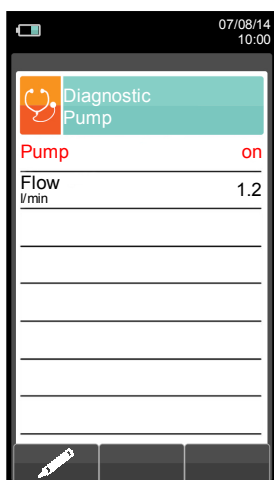

KEY	FUNCTION
	Activate the context keys shown on the display.
	In edit mode, cycling between on and off.
	Enters edit mode of the selected element and then confirms the change.
	Returns to the previous screen.

CONTEXT KEY	FUNCTION
	Enters edit mode: it is possible to turn the gas suction pump on and off.
	Confirms the modification.

9.7.5 Configuration→Diagnostic→On site cal.



KEY	FUNCTION
	Activate the context keys shown on the display.
	Sets the password.
	Selects line; the selected line is evidenced in red. In modification sets the value or the desired mode.
	Activates the context key located in the left side of the display.
	Returns to the previous screen. When in modify mode cancels the modification just made.

CONTEXT KEY	FUNCTION
	Once password is entered, gives access to the 'On site calibration' menu.
	Shows details for the selected sensor.
	Zeroes the timer.
	Enters the modification mode for the selected parameter.



Calibration procedure

To carry on the recalibration the following instruments are needed:

- Known concentration gas cylinder suitable for the sensor, complete with a pressure regulator
- Flow meter
- Hose with Tee fitting to connect the cylinder to the flow meter and to the instrument

In the following is described a recalibration example for the CO sensor.

1. Start the instrument

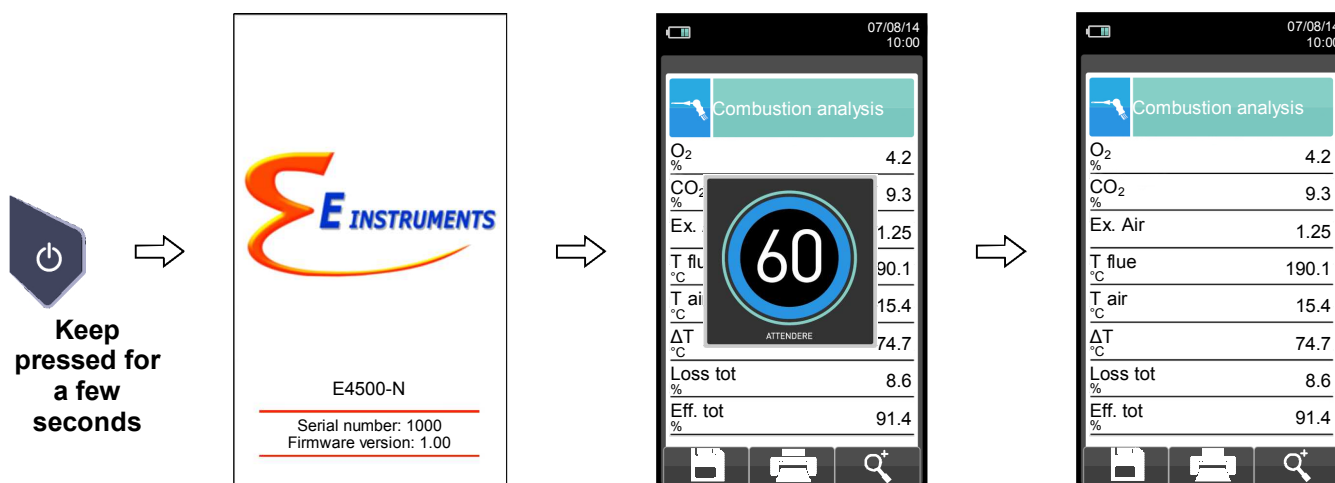

ATTENTION

- Make sure autozero is performed in clean air and completes properly.
- Do not connect the gas probe to the instrument.
- Check the battery charge level or connect the power adapter to avoid data loss during recalibration.

2. Once autozero is completed press the key and select the diagnostic icon.

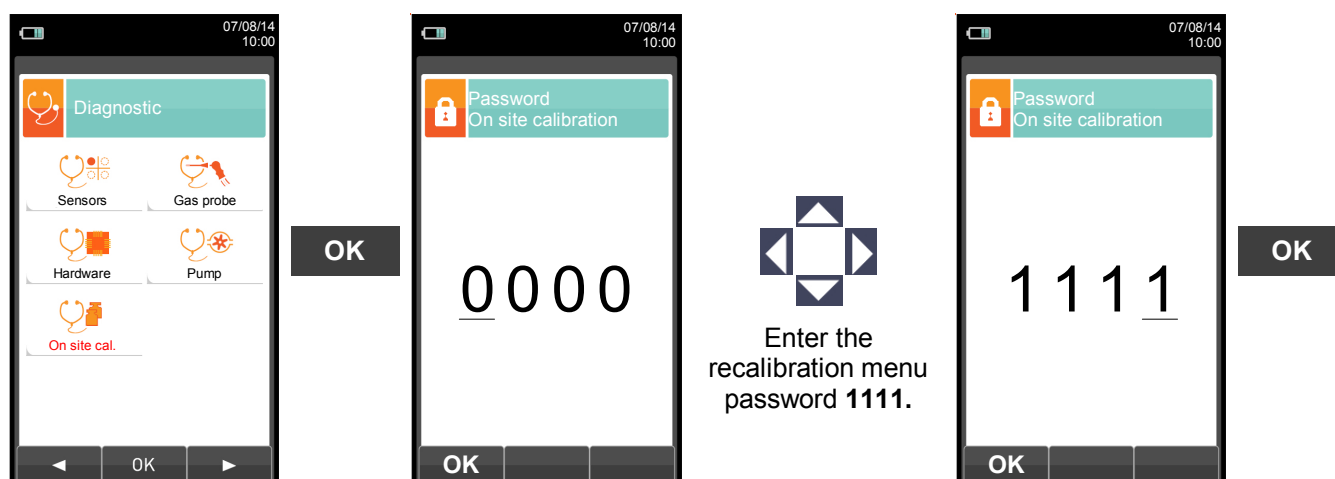



3. Once in the 'On site calibration' menu, the list of the installed sensors are shown for which the recalibration is available. In the recalibration screen all information related to the last performed calibration is shown, as well as the relevant values.

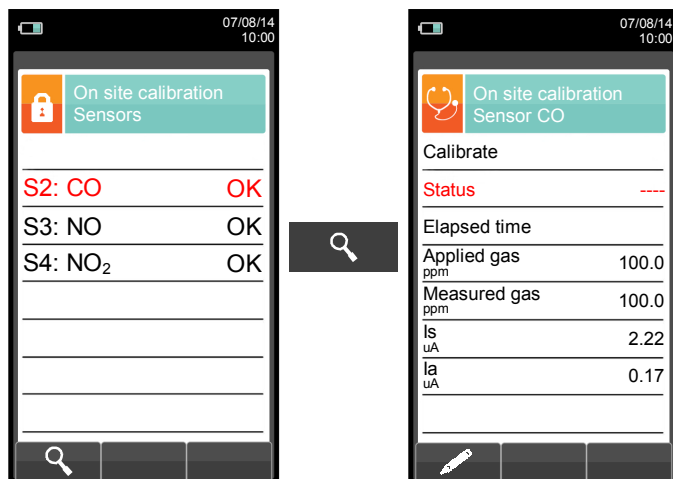

Calibrate: saves new calibration

Status: not active: returns to the factory calibration
 active: returns to the last calibration made by the user
 ----: no 'on site calibration' has been previously stored

Elapsed time: timer

Applied gas: enters the concentration of the applied calibration gas

Measured gas: measures the concentration of the applied gas

Is: 'Is' current from the sensor

Ia: 'Ia' current from the sensor

4. The following describes a recalibration example for CO sensor.

CHOOSE THE SENSOR TO BE RECALIBRATED AND PROCEED AS DESCRIBED (CO SENSOR EXAMPLE):

- Connect the known concentration gas cylinder to the instrument as shown in the following scheme:



WARNING!
 Adequate ventilation must be provided when working with toxic gases, particularly the flow meter and instrument outputs must be evacuated by a ventilation system.

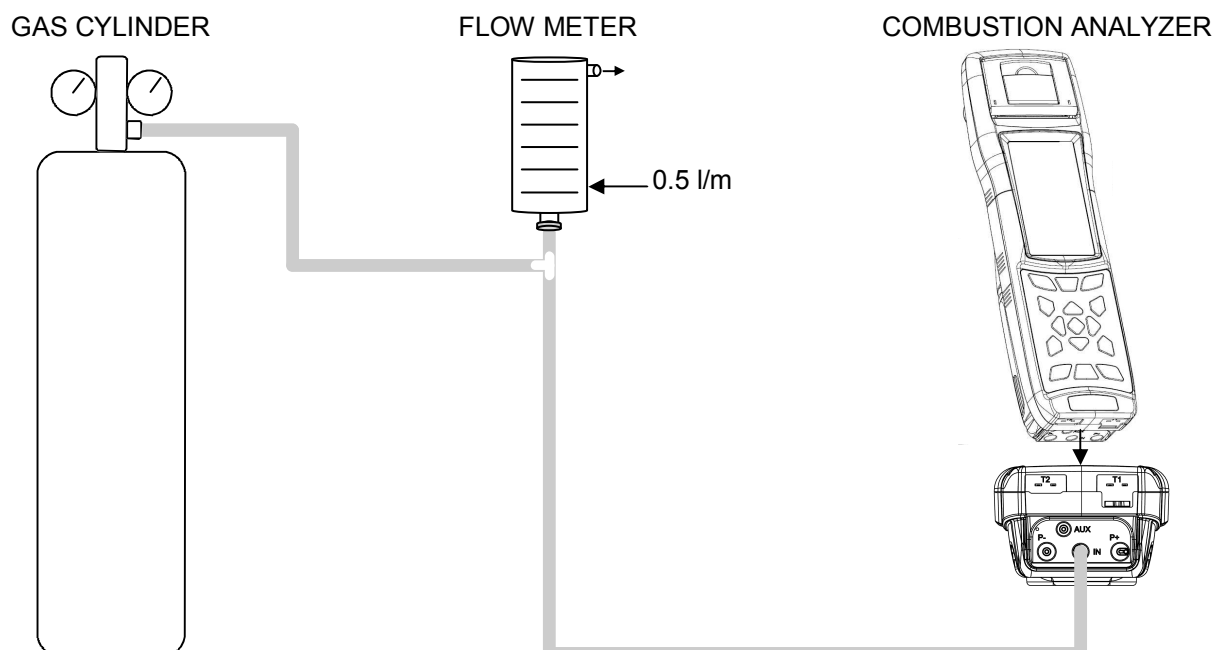

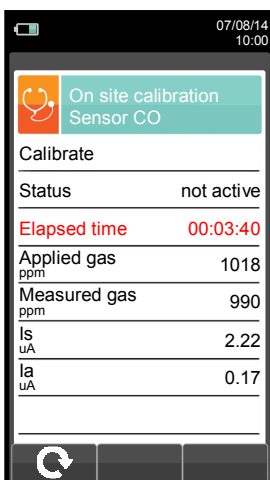
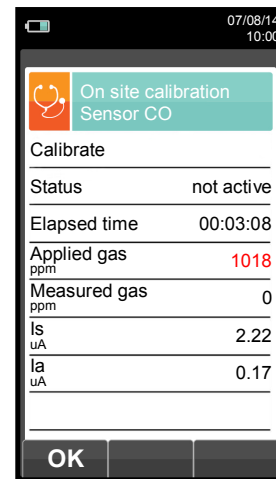
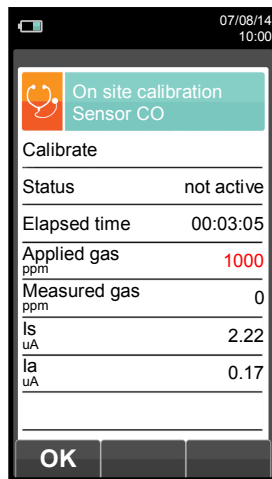
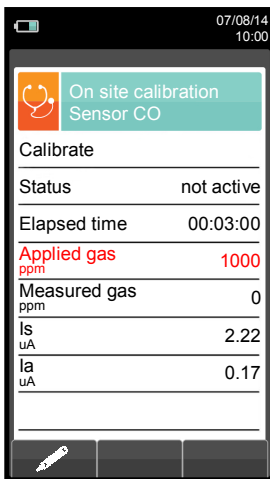
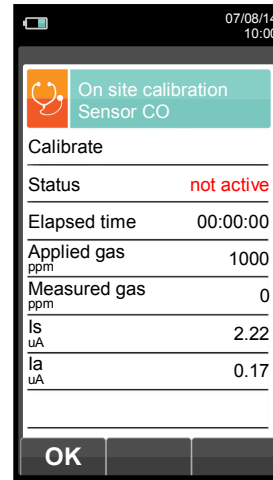
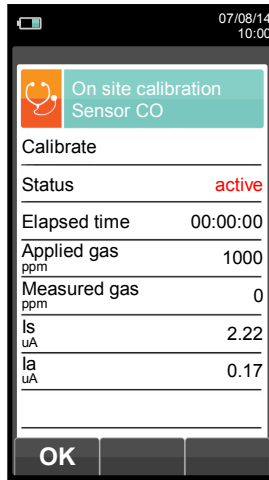
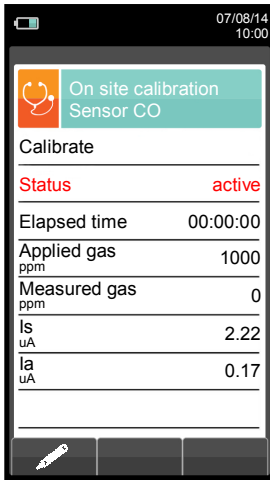

Zeroes the timer - helps to keep under control the time elapsing during the stabilization phase.

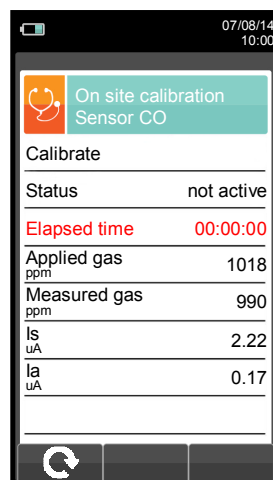

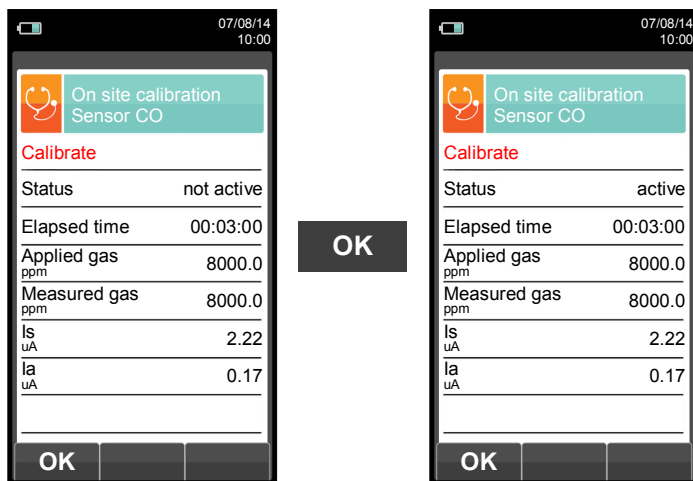
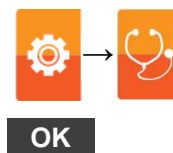

Messages in the 'Status' line:

saving: the instrument is saving the performed calibration

error: the sensor has NOT been recalibrated for any of the following reasons:

- The calibration gas cannot properly reach the instrument.
- Concentration for the calibration gas has not been set in the relevant line 'Applied gas'.
- The user didn't allow for the stabilization time to properly elapse.
- The sensor could be damaged or exhausted and must therefore be replaced.



WARNING

At any time the user can restore the factory calibration in the instrument by setting the 'Status' line on 'not active'.

In the following are listed the suggested stabilization times for the 'on site calibration' of the sensors.

- Sensor CO: 3 minutes
- Sensor NO: 3 minutes
- Sensor SO₂: 10 minutes
- Sensor NO₂: 10 minutes
- Sensor CxHy: 3 minutes
- Sensor CO₂: 3 minutes

9.8 Configuration→Language



KEY	FUNCTION
	Activate the context keys shown on the display.
	Scrolls through the available languages.
	Sets the selected language.
	Returns to the previous screen.

CONTEXT KEY	FUNCTION
	Sets the selected language.

9.9 Configuration→Restore

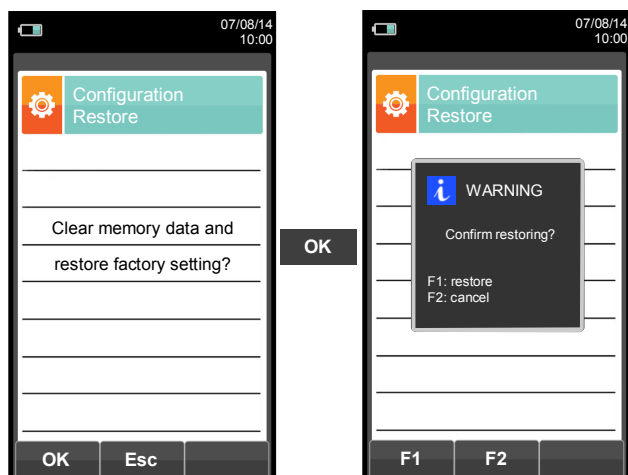

KEY	FUNCTION
	Activate the context keys shown on the display.
	Starts the factory data reset phase.
	Exits the current screen without resetting.

CONTEXT KEY	FUNCTION
	Starts the factory data reset phase.
	Exits the current screen without resetting.
	Factory reset.
	Cancels the factory data reset phase and goes back to the previous screen.

10.1 Memory Menu

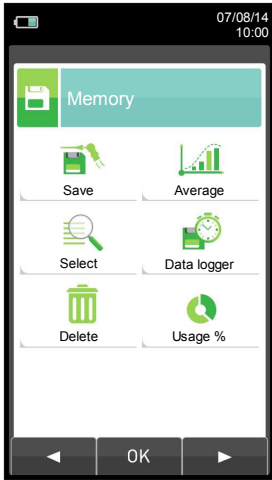



KEY	FUNCTION
	Activate the context keys shown on the display.
	Returns to the previous screen.

CONTEXT KEY	FUNCTION
	Selects the available parameters.
	Enters in the selected parameter setting.
	Selects the available parameters.

PARAMETER	DESCRIPTION
Save	From this screen the user can start the combustion analysis. The data shown summarizes the mode of analysis and the selected memory. SEE SECTION 10.2.
Average	Allows the user to see the average of the analyses contained in the selected memory. SEE SECTION 10.3.
Select	<ul style="list-style-type: none"> - Allows the user to set the number of the memory to be used to save the combustion analysis and/or the measurement of the draft, smoke test, etc. For each memory it is possible to enter the personal information of the customer (name of the customer, address, telephone number, type of boiler, etc.). - Allows the user to see and print the stored analyses, individually or as an average. The analyses can be found (via the context key "find") by memory location or by the date they were saved; it is also possible to see the draft, carbon black and ambient CO. In the menu "Find Memory" the activation of the Print Memory is enabled only on the page where the analyses or the draft, smoke test and ambient CO data are displayed. SEE SECTION 10.4.
Data logger	<p>This submenu allows the user to define the mode of analysis and of memory selection:</p> <p>Automatic analysis mode: UNI 10389 The factory settings of the device are in accordance with the Standard UNI 10389-1, which requires that you perform at least 3 samples spaced at least 120 sec.</p> <p>BImSchV The factory settings of the device are in accordance with the German standard BImSchV, which requires that you perform at least 30 samples spaced 1 sec.</p> <p>Data Logger This mode is entirely configurable by the user (it is necessary to set the number of samples to be acquired, the duration of acquisition of each sample and the printing mode). When the combustion analysis starts, the device will automatically carry out and store the number of samples set, spaced from one another according to the set time. After the combustion analysis (indicated by a beep), if the "Manual Print" mode has been selected, the device will display the average of the samples taken with the possibility to recall them individually; the user can then print them (total, complete, ...). On the contrary, if the user has selected the option "Automatic Print", the device will automatically proceed to print the analyses, according to the current printing settings, without displaying the average.</p>



 <p>Data logger</p>	<p>Warning: in automatic mode, the measurements of draft, smoke and ambient CO must be taken before starting the combustion analysis.</p> <p>Manual analysis mode If the user chooses the manual mode, he will perform the combustion analysis manually; in this case, the settings regarding printing and duration of the automatic analysis will not be considered. At this point the user can start the manual analysis after waiting two minutes so that the displayed values are stable: then he can proceed to save or directly print the test ticket of the analysis, which will be prepared in accordance with the previously configured settings. At the end of the three analyses, the screen with the average can be displayed, which also contains all the data necessary to fill in the booklet of the system or plant. In both modes, manual and automatic, the data displayed regarding the pollutants CO / NO / NO_x can be translated into normalized values (with reference to the concentration of O₂ previously set).</p> <p>Memory selection mode Manual: the memory will have to be selected manually via the parameter "Select" Auto: the memory, to which the measurements and combustion analyses will be saved, will be suggested automatically when the device is turned on. SEE SECTION 10.5.</p>
 <p>Delete</p>	<p>Allows the user to delete the contents of each memory or ALL memory spots. SEE SECTION 10.6.</p>
 <p>Usage %</p>	<p>The user, through this menu, can view the percentage of memory usage. SEE SECTION 10.7.</p>

10.2 Memory Menu → Save

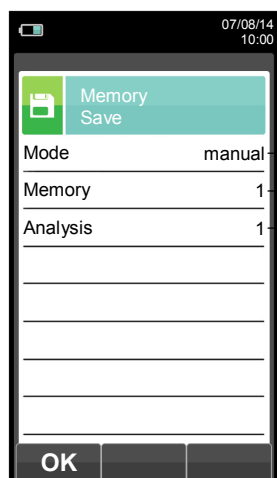

- ▶ Manual analysis mode
- ▶ Number of selected memory
- ▶ Number of analyses carried out

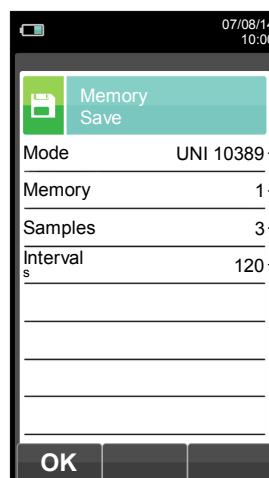

- ▶ Automatic analysis mode
- ▶ Number of selected memory
- ▶ Number of samples to take
- ▶ Interval between samples

KEY	FUNCTION
	Activate the context keys shown on the display.
	Starts saving the combustion analysis according to the mode set in the parameter 'Data logger'.
	Returns to the previous screen.

CONTEXT KEY	FUNCTION
	Starts saving the combustion analysis according to the mode set in the parameter 'Data logger'.
	Deletes the contents of the selected memory. (Visible when the selected memory contains previous analyses).
	Cancels the deletion of the contents of the selected memory. (Visible when the selected memory contains previous analyses).



Example 1: Saving the combustion analysis in manual mode

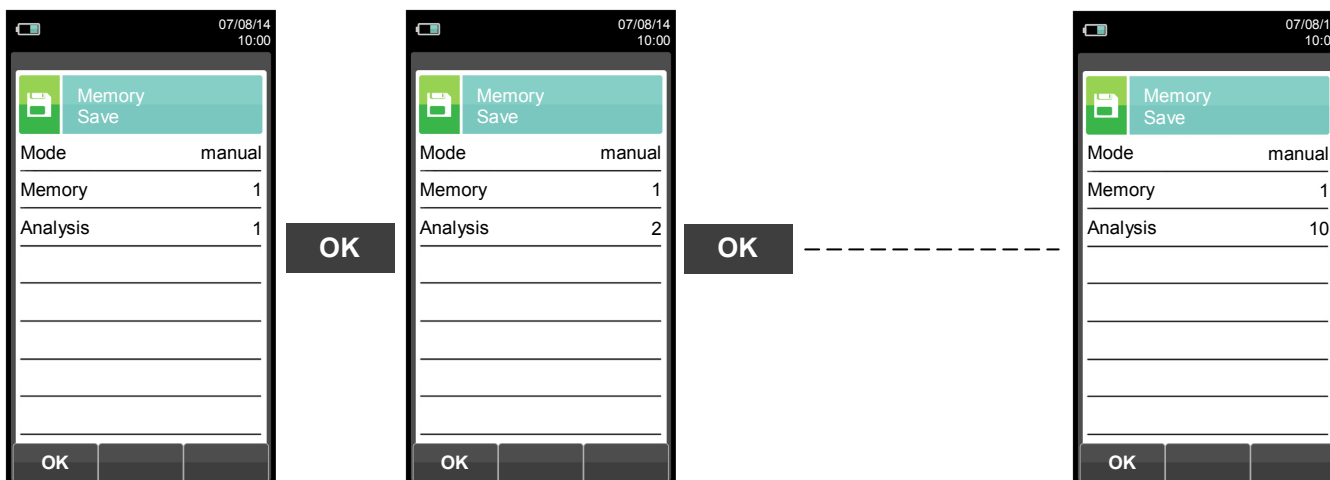

Example 2: Saving the combustion analysis in automatic mode (example UNI 10389)

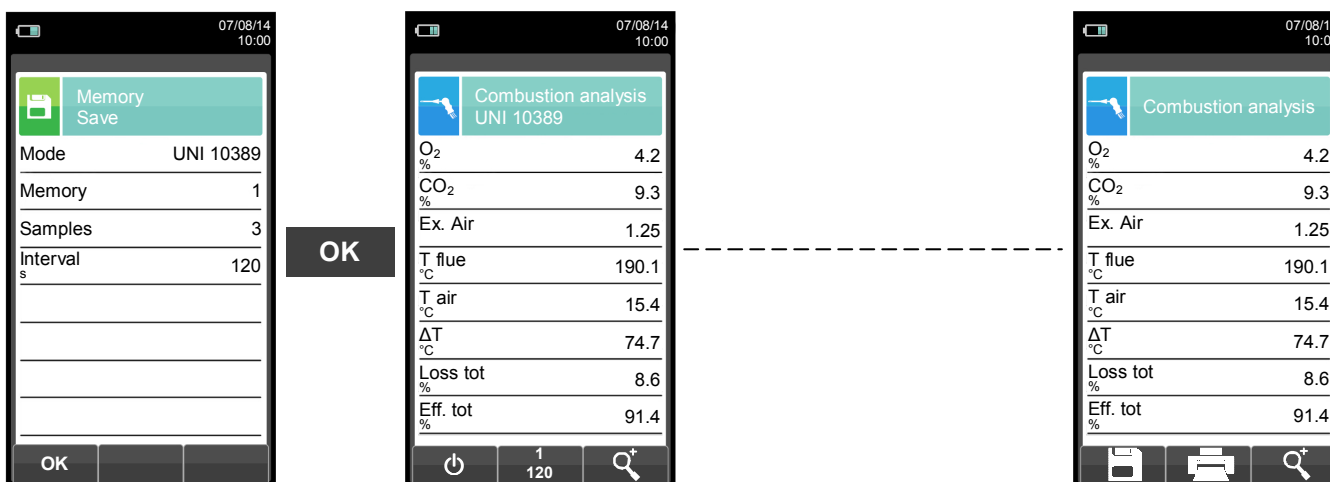

FOR ANY FURTHER INFORMATION SEE CHAPTER 13 'FLUE GAS ANALYSIS'.

10.3 Memory Menu→Average

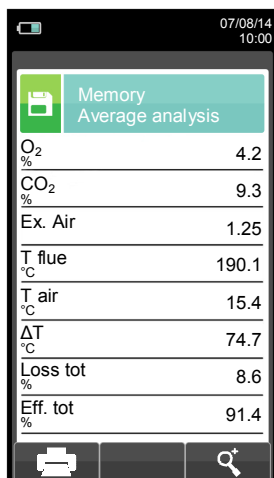

KEY	FUNCTION
	Activate the context keys shown on the display.
	Scrolls through the values of the average analysis.
	Activates the context key located in the left side of the display.
	Returns to the previous screen without saving the changes made.

CONTEXT KEY	FUNCTION
	Zoom. By pressing this interactive key repeatedly, the device displays the following sequence: AAA → AAA → AAA → AAA
	Starts printing the test ticket. SEE SECTION 11.

10.4 Memory Menu → Select

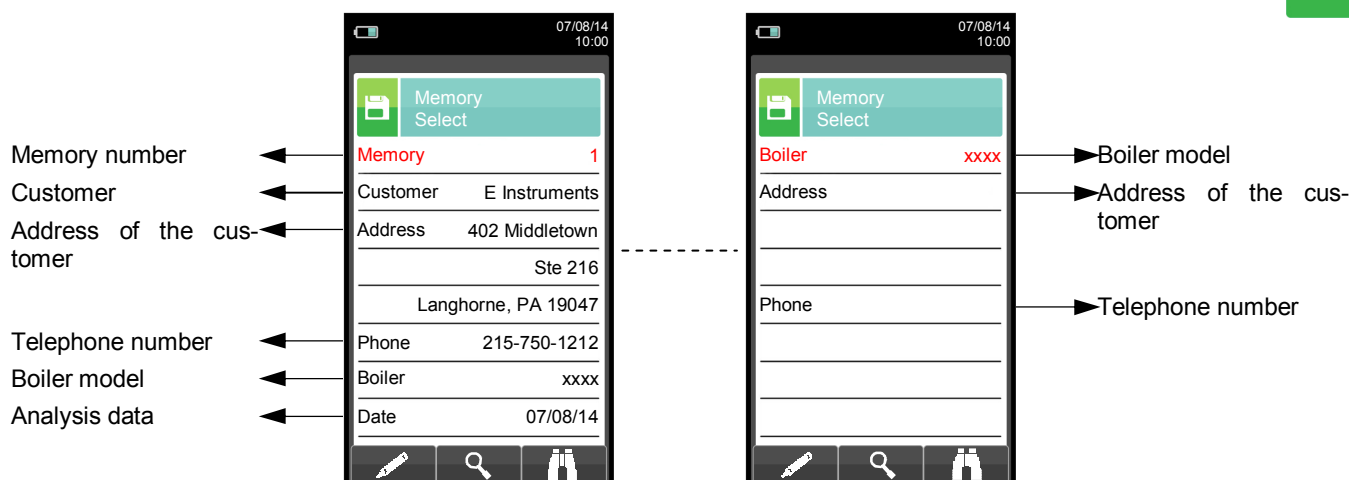

KEY	FUNCTION
	Activate the context keys shown on the display.
	In "edit text"/"search for data"/"search for memory number": it moves the cursor on the box corresponding to the desired letter or number.
	Selects line; the selected line is evidenced in red.
	Activates the context key located in the left side of the display.
	Returns to the previous screen without saving the changes made.

CONTEXT KEY	FUNCTION
	Enters the modification mode for the selected parameter. It is possible to select the number of the memory to use for the combustion analysis and/or to enter the information relative to the plant.
	Recall memory. By activating this function, the user has the possibility to view the data present in the selected memory. Measurement conditions, single analysis, average analysis. SEE SECTION 10.4.1
	Search function. Thanks to this function, the user has the possibility to quickly search for a specific analysis. The search can be carried out considering the memory number (by selecting the parameter "Memory"), the customer (by selecting one of the following parameters: "Customer", "Address", "Telephone" or "Generator") or the date (by selecting the parameter "Date").
	Confirms the settings and, if the search function is enabled, it starts the research.
	In "Edit text" it confirms the input of the selected letter or number.
	In "Edit text" it cancels the letter or number that precedes the cursor.
	In "Edit text" it goes from uppercase to lowercase, to symbols, to special characters.
	Selects the memories within the range of the research carried out.
	Selects the memories within the range of the research carried out.

10.4.1 Memory Recall

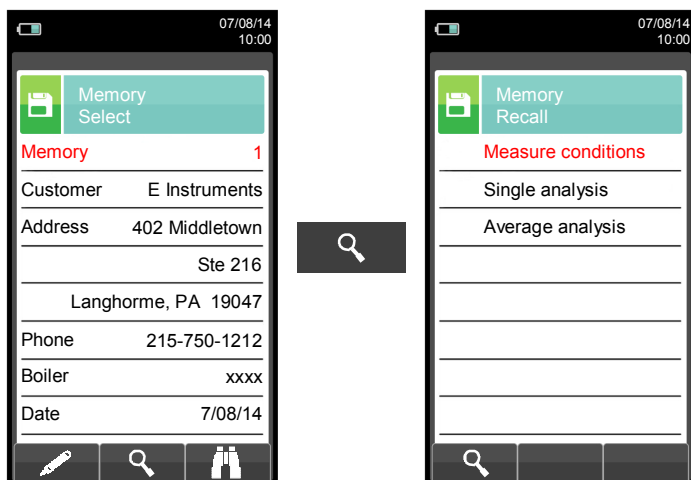

KEY	FUNCTION
	Activate the context keys shown on the display.
	Selects line; the selected line is evidenced in red.
	Activates the context key located in the left side of the display.
	Returns to the previous screen.

CONTEXT KEY	FUNCTION
	Displays the details of the selected parameter.

1. Details of measurement conditions

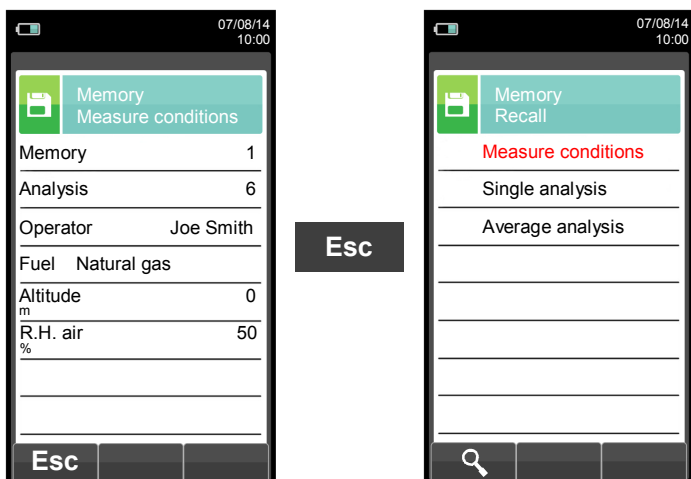

CONTEXT KEY	FUNCTION
	Returns to the previous screen.



2. Details of Single analysis

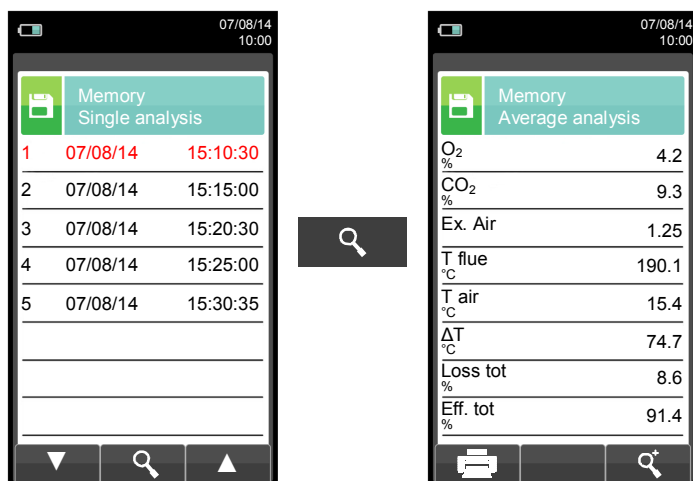

KEY	FUNCTION
	Activate the context keys shown on the display.
	Selects line; the selected line is evidenced in red. In "view detail" the previous or next pages are shown.
	Views the details of the selected parameter.
	Returns to the previous screen.

CONTEXT KEY	FUNCTION
	Selects line; the selected line is evidenced in red.
	Views the details of the selected parameter.
	Selects line; the selected line is red.
	Goes to next page.
	Goes to previous page.
	Starts printing the test ticket. See section 10.
	Zoom. By pressing this interactive key repeatedly, the device displays the following sequence: AAA → AAA → AAA → AAA



3. Average interval details

Defines the starting sample to define the analysis average.

Defines the end sample to define the analysis average.

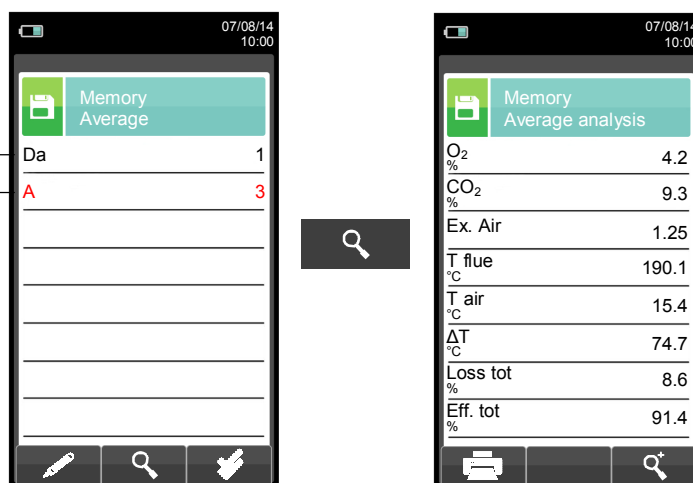

KEY	FUNCTION
	Activate the context keys shown on the display.
	In edit mode, it sets the number of the desired sample; the number to change is red.
	Selects line; the selected line is evidenced in red.
	Activates the context key located in the left side of the display.
	Returns to the previous screen without saving the changes made.

CONTEXT KEY	FUNCTION
	Enters edit mode: it is possible to select the number of the sample to use to have the average of the analysis carried out.
	Shows the average analysis in the interval set.
	Zoom. By pressing this interactive key repeatedly, the device displays the following sequence: AAA → AAA → AAA → AAA
	Sets all the samples of the analyses carried out: From 1 (first sample) To xxx (last sample).
	Confirms the settings.
	Starts printing the test ticket. SEE SECTION 11.

10.5 Memory Menu → Data logger

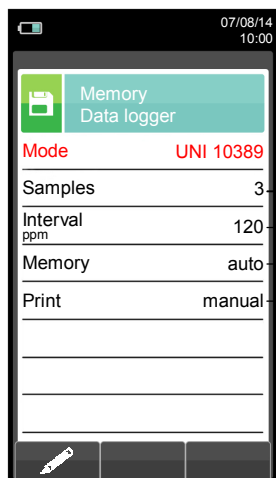

- ▶ The selectable analysis modes are: **manual - UNI 10389 - BlmSchV - data logger**
- ▶ Number of samples to make (parameter not visible in manual analysis mode).
- ▶ Period of acquisition of each sample (parameter not visible in manual analysis mode).
- ▶ The memory selection modes are: **manual** or **auto**.
If "**auto**" mode has been selected, the research of the available memory will be performed automatically when the device is turned on).
- ▶ The selectable printing modes are: **manual** or **auto**.
If "**auto**" mode has been selected, the printing will be performed automatically at the end of the combustion analysis (parameter not visible in manual analysis mode).

KEY	FUNCTION
	Activate the context keys shown on the display.
	Selects line; the selected line is evidenced in red.
	Activates the context key located in the left side of the display.
	Returns to the previous screen.

CONTEXT KEY	FUNCTION
	Enters the modification mode for the selected parameter.
	Confirms the settings.

10.6 Memory→Delete

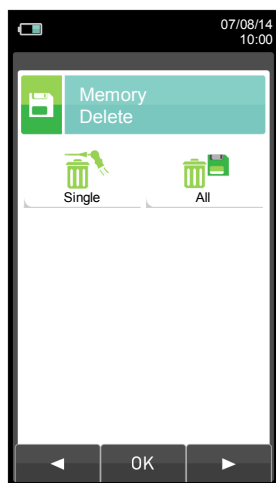

KEY	FUNCTION
	Activate the context keys shown on the display.
	Returns to the previous screen.

CONTEXT KEY	FUNCTION
	Selects the available parameters.
	Enters in the selected parameter setting.
	Selects the available parameters.

PARAMETER	DESCRIPTION
 Single	This option allows the user to delete the contents of each individual memory; to do this, the user will have to confirm the operation so as to avoid losing previously saved data. SEE SECTION 10.6.1.
 All	This option allows the user to delete the contents of ALL memories; to do this, the user will have to confirm the operation so as to avoid losing previously saved data. SEE SECTION 10.6.2.

10.6.1 Memory→Delete→Single



Memory number ←

Customer ←

Address of the customer ←

Telephone number ←

Boiler model ←

Date of analysis ←

KEY	FUNCTION
	Activate the context keys shown on the display.
	In "edit text"/"search for data"/"search for memory number": it moves the cursor on the box corresponding to the desired letter or number.
	Selects line; the selected line is evidenced in red.
	Activates the context key located in the left side of the display. In "edit text": Confirm the text.
	Returns to the previous screen.

CONTEXT KEY	FUNCTION
	Search function. Thanks to this function, the user has the possibility to quickly search for a specific analysis. The search can be carried out considering the memory number (by selecting the parameter "Memory"), the customer (by selecting one of the following parameters: "Customer", "Address", "Telephone" or "Generator") or the date (by selecting the parameter "Date").
	Confirms the settings and, if the search function is enabled, it starts the research.
	In "Edit text" it confirms the input of the selected letter or number.
	In "Edit text" it cancels the letter or number that precedes the cursor.
	In "Edit text" it goes from uppercase to lowercase, to symbols, to special characters.
	Selects the memories within the range of the research carried out.
	Selects the memories within the range of the research carried out.
	Starts deleting the selected memory.
	Deletes the selected memory.
	Cancel the deleting and goes back to the previous page.

10.6.2 Memory→Delete→All

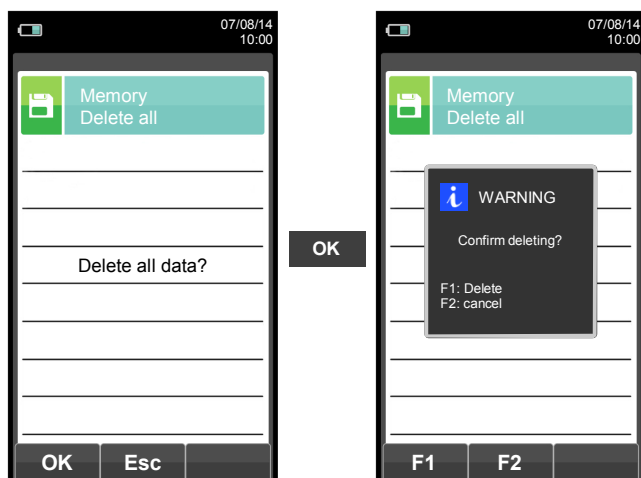

KEY	FUNCTION
	Activate the context keys shown on the display.
	Start erasing all memories.
	Returns to the previous screen.

CONTEXT KEY	FUNCTION
	Start erasing all memories.
	Returns to the previous screen.
	Deletes all memories.
	Cancel the deleting and returns to the previous page.

10.7 Memory→Usage %

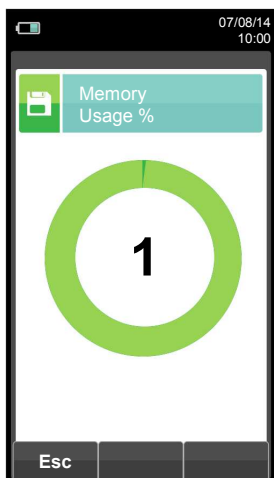

KEY	FUNCTION
	Activate the context keys shown on the display.
	Returns to the previous screen.

CONTEXT KEY	FUNCTION
	Returns to the previous screen.

11.1 Print

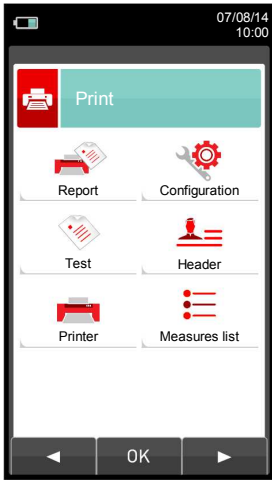

KEY	FUNCTION
	Activate the context keys shown on the display.
	Returns to the previous screen.

CONTEXT KEY	FUNCTION
	Selects the available parameters.
	Enters in the selected parameter setting.
	Selects the available parameters.

PARAMETER	DESCRIPTION
Report	Enables the Print Menu. Allows to print the combustion analysis data on a paper ticket which reports the measurement values. The printed values are those shown on the display when the menu is enabled. This menu can be used for combustion analysis, even when recalled from the memory, for draft, smoke, ambient gas and for tightness test results. SEE SECTION 11.2.
Configuration	The user, by means of this menu, can set the test ticket printing mode: Copies: Allows to set the number of printed copies and layout of the ticket. Several copies of the test ticket can be printed, choosing among different layouts according to the information included. Model: The ticket layout selection is only valid for combustion analysis and can be chosen among Complete, Partial and Total. Tickets for draft, smoke, ambient gas concentration and tightness test only allow a specific layout. Layouts for combustion analysis are specified as described in the following: Full: includes a header with company data as well operator data previously programmed in the configuration menu, measurements sampled in the combustion analysis and, when sampled, the draft, smoke and CO ambient gas values. Partial: only reports the combustion analysis measurement values and information, without any header, comments or blank lines for operator comments. Total: is arranged with the complete. SEE SECTION 11.3.
Test	Paper feed: Feeds paper in the printer; this function is most useful when replacing the paper roll in the printer. Print: Prints a graphical/alphanumeric test ticket for a complete check of the printer operation. SEE SECTION 11.4.
Header	It allows the user to enter, in six lines of 24 characters the name of the Company or owner of the device or the information regarding the latter (e.g. address, telephone number), which will be printed in the header of the analysis report. SEE SECTION 11.5.
Pairing	Selects the printer type: internal or Bluetooth. When Bluetooth printer is selected a pairing procedure will be needed in order to match the printer to the instrument. The pairing procedure has to be performed only once. SEE SECTION 11.6.
Measures list	In this submenu the user has the possibility to view the list of measurements that the device performs. With the interactive keys, the user can add, delete or move a selected measurement. SEE SECTION 11.7.



11.2 Print→Report

```

Date: 07/08/14
Time: 10.10
Fuel: Natural gas
Altitude: 0 m
R.H. air: 50 %
O2          4.2 %
CO2         9.3 %
EX. Air     1.25
T flue     190.2 °C
T air      15.4 °C
ΔT         174.8 °C
Loss tot   8.6 %
Eff. tot   91.4 %
ET         4.9 %
ηt         91.4 %
CO         148 ppm
NO         40 ppm
NOX/NO:    1.03
NOX        41 ppm
CO amb     0 ppm
Draft:     0.05 hPa
T out:     20 °C
Smoke:    3 1 2
Aver. n:   2
    
```

KEY	FUNCTION
	Activate the context keys shown on the display.
	Returns to the previous screen.

CONTEXT KEY	FUNCTION
	Starts printing the test ticket.
	Stops printing the test ticket.

11.3 Print→Configuration

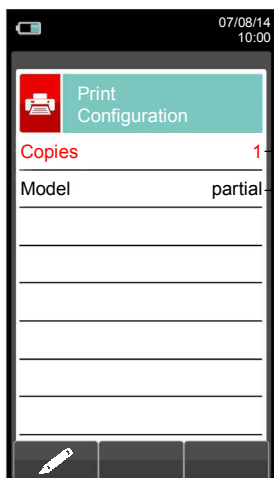

- ▶ Set the number of copies to print: 1 .. 5.
- ▶ The test ticket models that can be selected are: **partial - full - total**

KEY	FUNCTION
	Activate the context keys shown on the display.
	Selects line; the selected line is evidenced in red. In modification sets the value or the desired mode.
	Activates the context key located in the left side of the display.
	Returns to the previous screen. When in modify mode cancels the modification just made.

CONTEXT KEY	FUNCTION
	Enters the modification mode for the selected parameter.
	Confirms the settings.

Example:

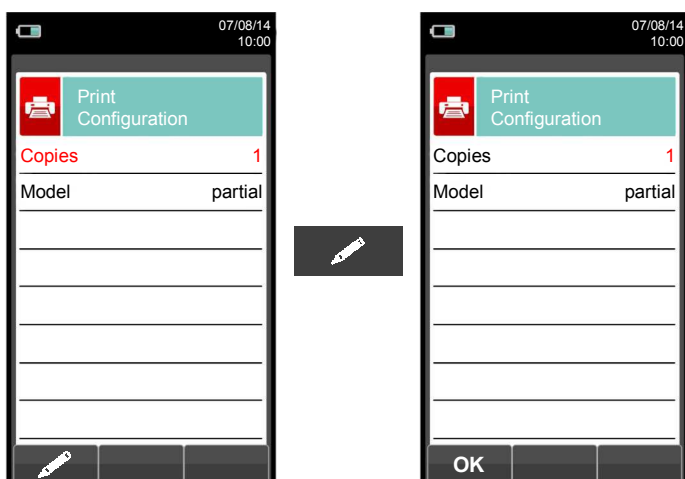

11.4 Print→Test

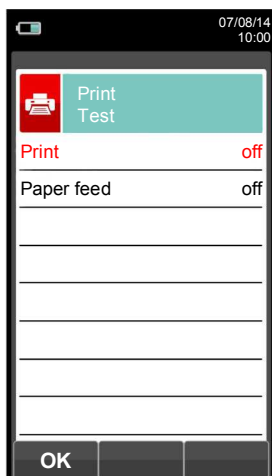

KEY	FUNCTION
	Activate the context keys shown on the display.
	Selects line; the selected line is evidenced in red. In modification sets the value or the desired mode.
	Activates the context key located in the left side of the display.
	Returns to the previous screen. When in modify mode cancels the modification just made.

CONTEXT KEY	FUNCTION
	Confirms the settings.

Example:

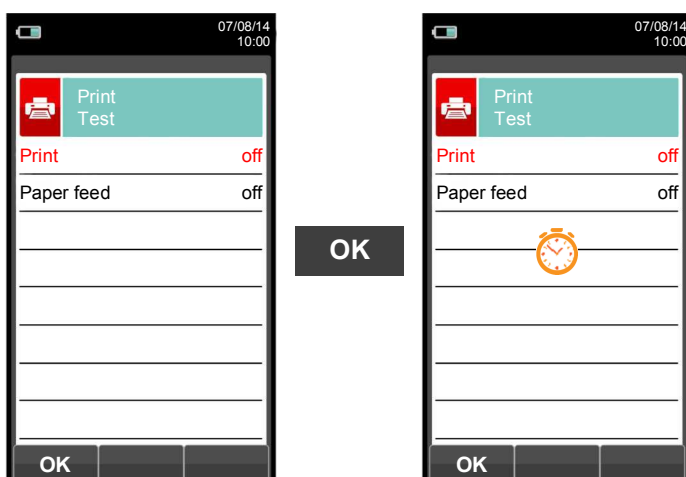

11.5 Print→Header

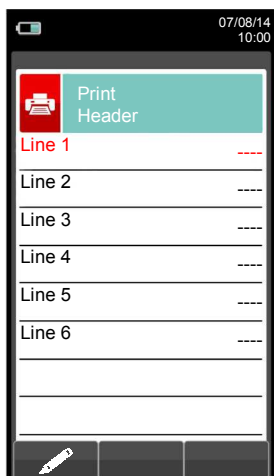

KEY	FUNCTION
	Activate the context keys shown on the display.
	In "edit text": It moves the cursor on the box corresponding to the letter or number required to form the desired word.
	In edit mode it moves the cursor through the available lines.
	In "edit text": it confirms the text input. In "Print header": It activates the context key displayed on the left.
	Returns to the previous screen. In "edit text" it goes back to the previous screen without saving the changes made.

CONTEXT KEY	FUNCTION
	Enters edit mode of the selected line: it is possible to enter the name of the operator (24 characters available).
	Confirms the selected letter or digit.
	Cancel the letter or digit before the cursor.
	Cycles through uppercase, lowercase, symbols and special characters.



Example:

1. Edit text

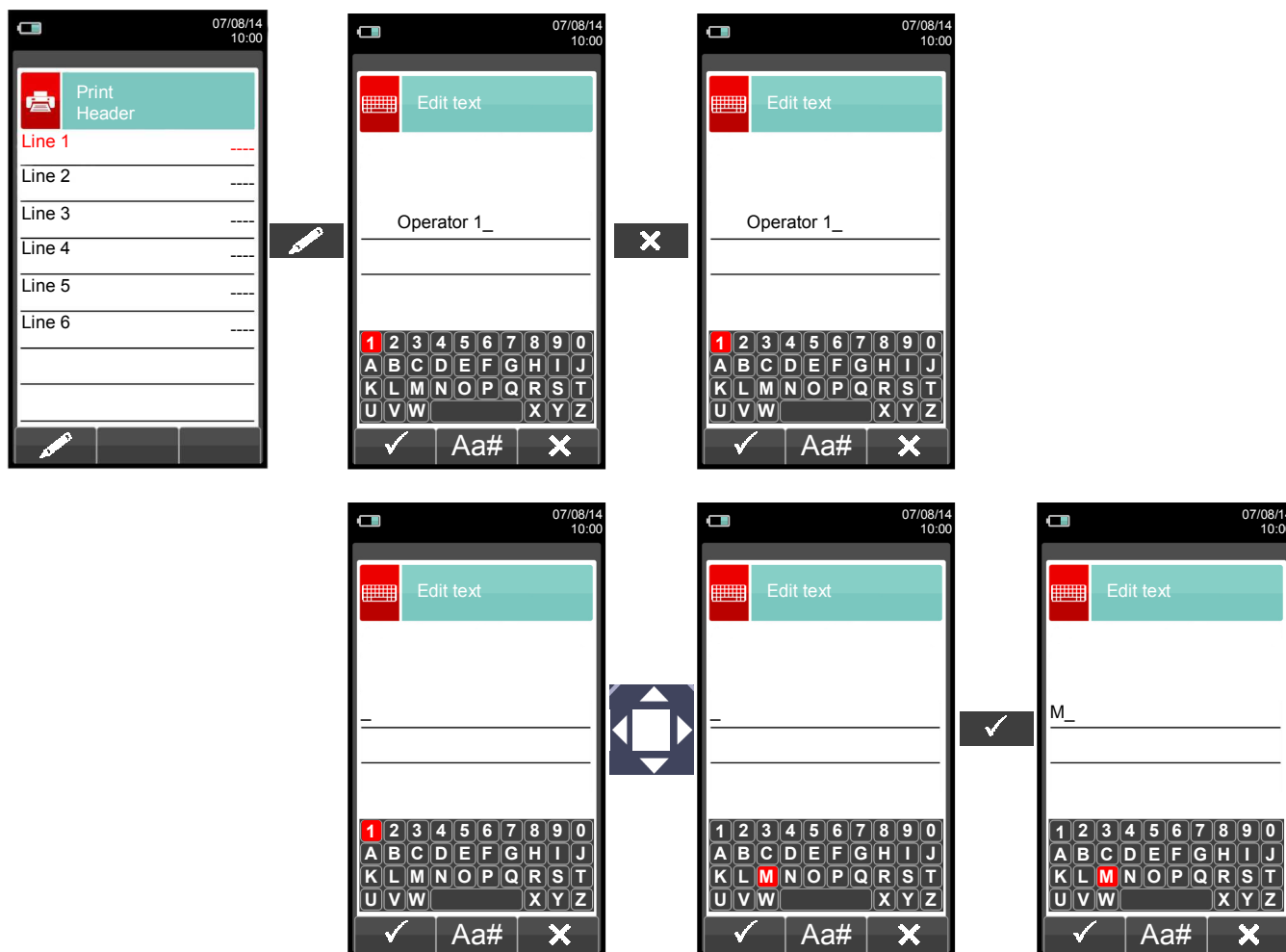

11.6 Print→Printer

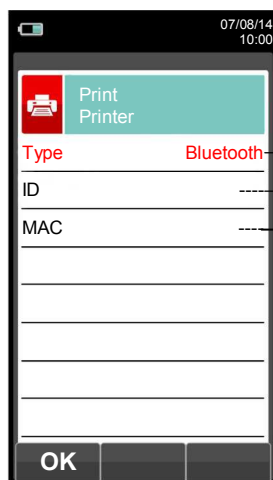
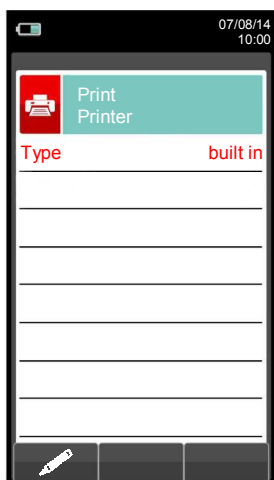

- ▶ Printer type: **built in (internal) - Bluetooth (external)**.
- ▶ Name of the Bluetooth printer associated with the instrument.
- ▶ Address of the Bluetooth printer associated with the instrument.

KEY	FUNCTION
	Activate the context keys shown on the display.
	Selects line; the selected line is evidenced in red. In modification sets the value or the desired mode.
	Activates the context key located in the left side of the display.
	Returns to the previous screen. When in modify mode cancels the modification just made.

CONTEXT KEY	FUNCTION
	Enters the modification mode for the selected parameter.
	Confirms the settings.

11.6.1 Print→Pairing

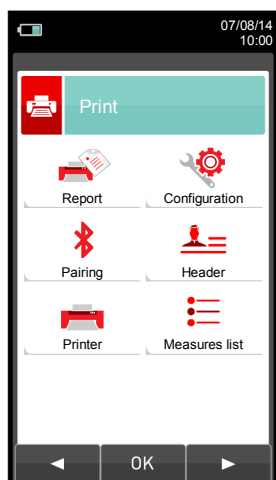

KEY	FUNCTION
	Activate the context keys shown on the display.
	Selects line; the selected line is evidenced in red. In modification sets the value or the desired mode.
	Activates the context key located in the left side of the display.
	Returns to the previous screen. When in modify mode cancels the modification just made.

CONTEXT KEY	FUNCTION
	Selects the available parameters.
	Enters in the selected parameter setting.
	Selects the available parameters.
	Starts the search for Bluetooth devices.
	Quits and returns to the previous screen.
	Enters the modification mode for the selected parameter.
	Repeats the pairing procedure.
	Confirms the settings.
	Confirms the selected letter or digit.
	Cancels the letter or digit before the cursor.
	Cycles through uppercase, lowercase, symbols and special characters.

In the following pages the pairing procedure between the instrument and a Bluetooth printer is described.



1. Once the Bluetooth printer is configured, proceed as follows:

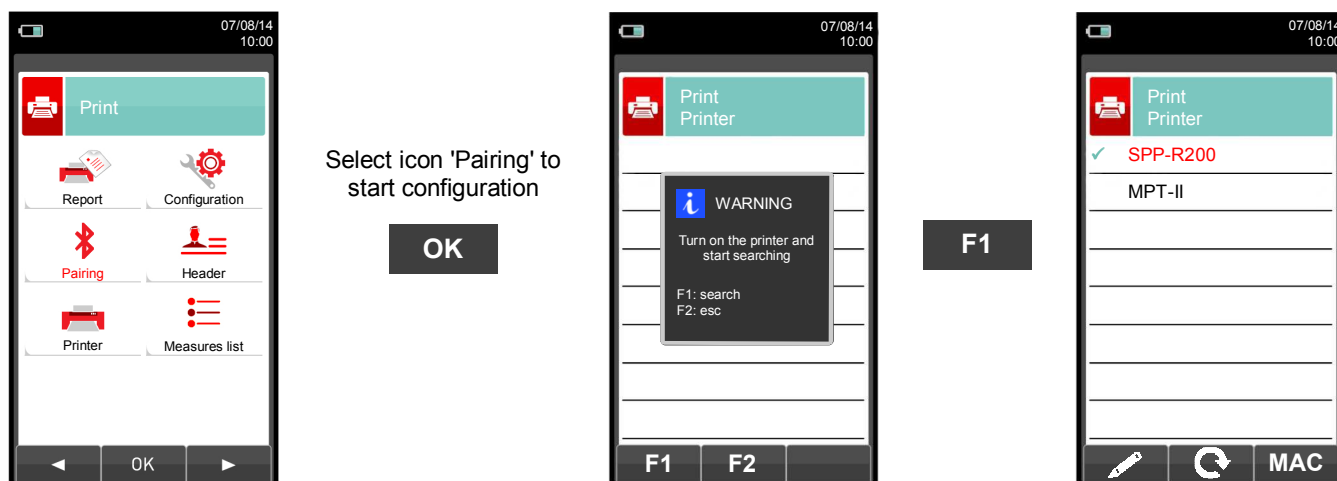

2. Select the line corresponding to the desired Bluetooth printer, then proceed as follows:

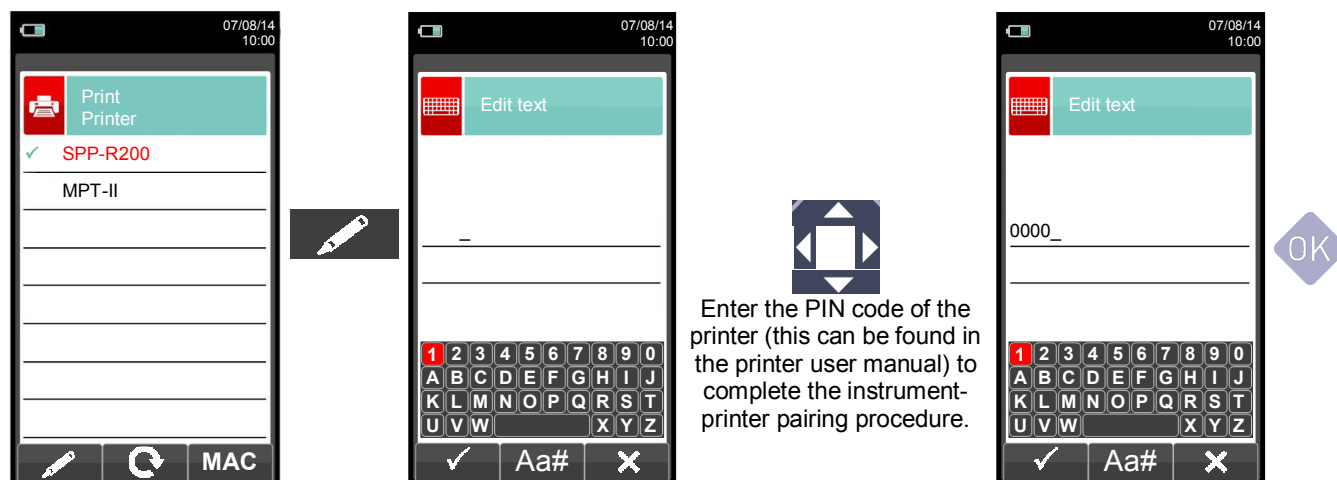

3. The instrument-printer pairing is completed. Press key '  ' to return to the previous screen.

11.7 Print→Measures list

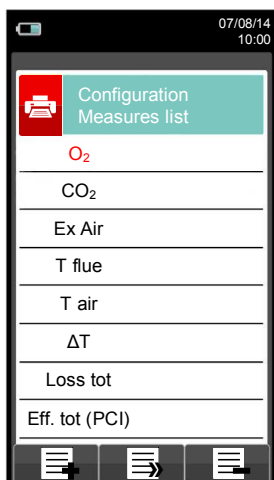

KEY	FUNCTION
	Activate the context keys shown on the display.
	Selects the available measurements from the suggested list. In edit mode, it scrolls through the measurements present.
	Confirms the modification.
	When pressed in modify mode cancels the selection made, otherwise returns to the previous screen.

CONTEXT KEY	FUNCTION
	Adds a measurement.
	Moves the position of a measurement.
	Deletes a measurement from the list.
	Scrolls through the available measurements.
	Confirms the change made.
	Scrolls through the available measurements.
	Cancels the change made.



Example:

1. Add a measurement to the list

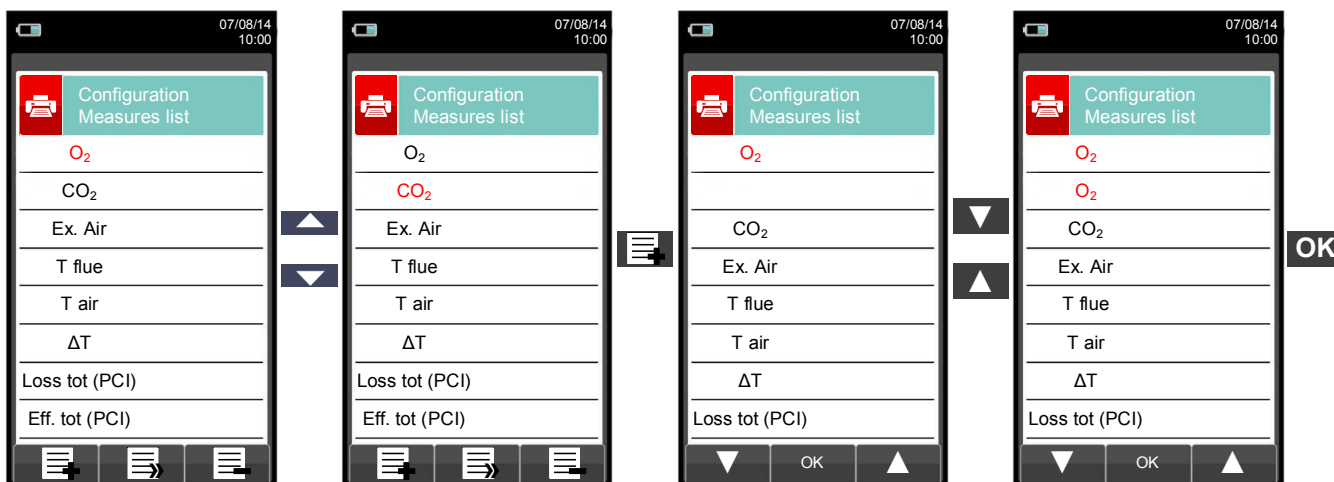

2. Move the position of a measurement

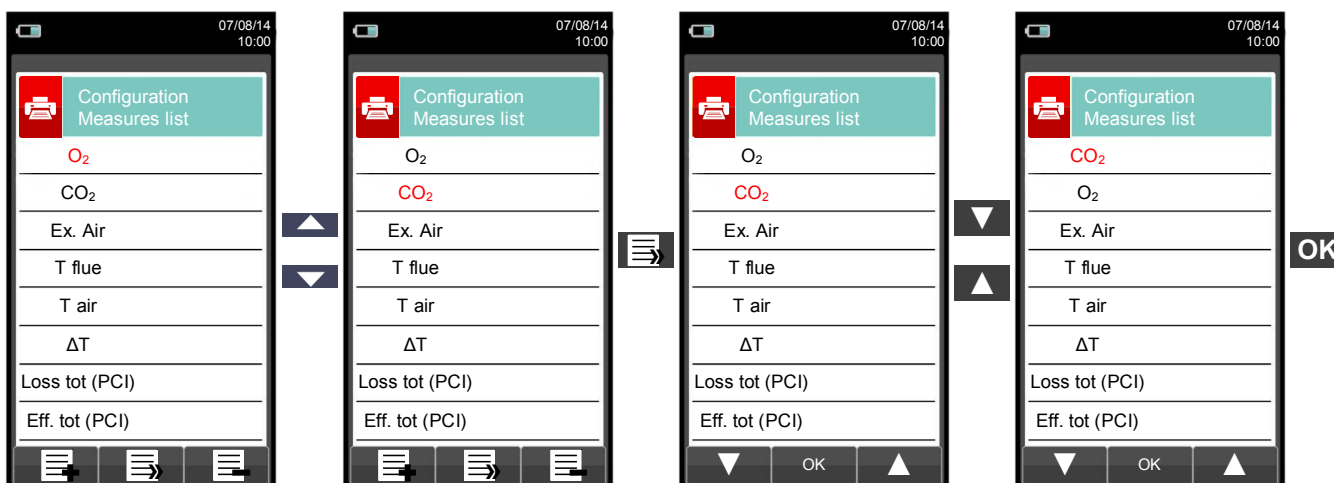

3. Deletes a measurement from the list

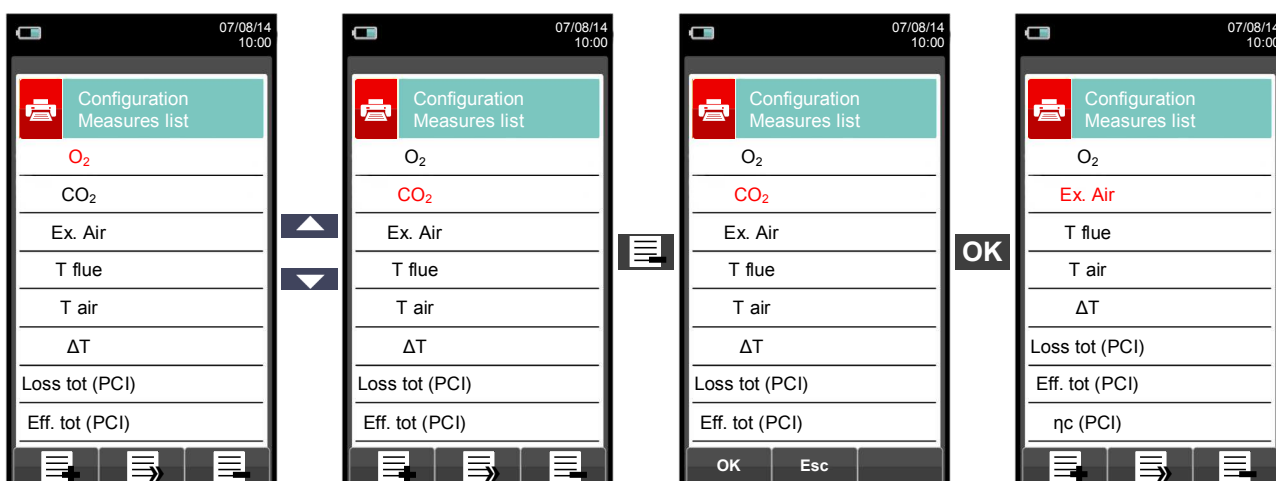

12.1 READINGS

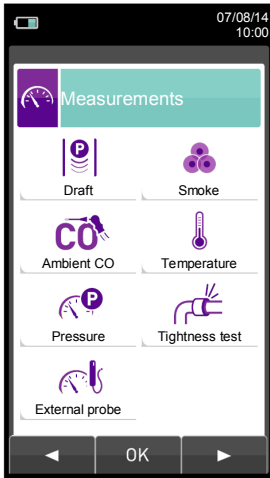





KEY	FUNCTION
	Activate the context keys shown on the display.
	Returns to the previous screen.

CONTEXT KEY	FUNCTION
	Selects the available parameters.
	Enters in the selected parameter setting.
	Selects the available parameters.

PARAMETER	DESCRIPTION
 Draft	<p>The DRAFT menu gives access to the stack draft measurement. Being a negative pressure, in accordance with standard UNI10845, draft must be measured using the negative pressure input P-. The correct values for a natural draft boiler are therefore positive by definition. Before performing the measurement the instrument allows the user to input the external air temperature as required by the standard. Afterwards the user can acquire the value displayed in order to add it to the running analysis measurements or, alternatively, print the relevant ticket through the 'PRINT' menu.</p> <p>NOTE: The measurement may not be accurate due to condensation inside the gas probe. Should you notice an inaccurate or unstable reading on the instrument, it is advisable to disconnect the gas probe from the instrument itself, and purge pipes by blowing with a compressor. In order to be sure there is no humidity, it is suggested to perform the measurement by means of the transparent rubber pipe supplied on issue. SEE SECTION 12.2.</p>
 Smoke	<p>It is possible to enter the data concerning one to three SMOKE TEST measurements taken by means of an optional device (MANUAL SMOKE PUMP); see the relevant instructions. The method consists in taking a certain quantity of combustion gas from the middle of the flue behind the surfaces of the exchangers at the end of the boiler, and make it pass through a special filter paper. The soot stain obtained is compared with the surfaces blackened in a different way according to a comparison scale; it is thus determined the "soot number", which will be entered in the instrument manually.</p> <p>These measurements can be either stored in memory together with the combustion analysis data or printed on a ticket.</p> <p>SEE SECTION 12.3.</p>
 Ambient CO	<p>This type of analysis lets the user measure the CO value present in the environment, with the scope of checking the personal safety conditions of a specific working environment. The instrument leaves our factory with the following preset threshold values:</p> <p>COmax: 35 ppm Recommended exposure limit (REL) stipulated by the National Institute for Occupational Safety and Health (NIOSH), equivalent to 40 mg/m³ and calculated as an 8-hour Time-Weighted Average (TWA).</p> <p> It is compulsory to perform the autozero in the clean air, so that the ambient CO measurement is correct. It is advisable to turn on the instrument and wait for the autozero completion outside the area where the test is being performed.</p> <p>SEE SECTION 12.4.</p>



PARAMETER	DESCRIPTION
 Temperature	<p>With this menu it is possible to measure the temperature of the supply water, by means of an OPTIONAL thermocouple K-type contact probe to be connected to the input T1. Also, it is also possible to measure the temperature of the return water, by connecting an OPTIONAL thermocouple K-type contact probe to be connected to the input T1. With the function ΔT it is possible to obtain the relative temperature difference. SEE SECTION 12.5.</p>
 Pressure	<p>It is possible, through the use of the external flexible pipe made in RAUCLAIR (supplied), to measure a pressure value within the range stated in the technical features (connect the pipe to P+ input). During the pressure measurement the 'HOLD' function is made available, which allows to 'freeze' the value shown on the display, by pressing 'HOLD' key. SEE SECTION 12.6.</p>
 Tightness test	<p>The E4500 can perform the tightness test on heating plants which use combustible gases according to the standards UNI 7129 and UNI 11137: 2012, respectively applicable to new or renewed pipings and to existing pipings. The result of this tightness test, whose steps are described in the following, can be printed, once acquired, by starting the ' print menu ' in any of the screens of the ' Tightness Test ' menu. SEE SECTION 12.7.</p>
 External probe	<p>Not available.</p>

12.2 Readings → Draft

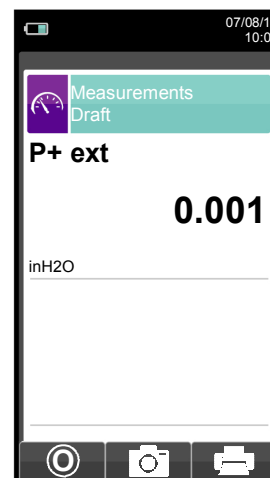
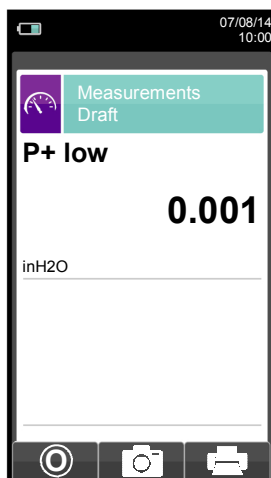



To measure the draft proceed as follows:

- Connect the probe pressure input hose to the instrument **P+** input.
- Enter the external air temperature.
- Before starting the pressure zeroing sequence pay attention to remove the gas probe from the stack.

- Having carried out the pressure zeroing sequence, insert the probe in the chimney and measure the draft.



- The draft values to be stored in the memory must be acquired before storing the analysis data.







- To attach the draft value to the readings of the current analysis, activate the "save" function '  '

- To print the test ticket with the value of the draft, activate the function '  '

- It is possible to cancel an acquired draft from the memory; to overwrite a new one, activate the "save" function again '  '





- After saving the draft measurement, to carry out the combustion analysis, press the key '  '

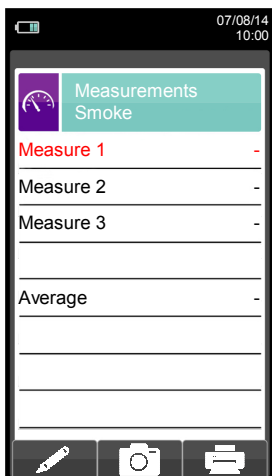

KEY	FUNCTION
	Activate the context keys shown on the display.
	Sets the value of the external temperature.
	Returns to the previous screen.





CONTEXT KEY	FUNCTION
  	The activation of one of these keys starts the Draft measurement.
	Carries out pressure zeroing.
	Saves, in the memory selected in the "Memory Select" menu, the value of the draft measured.
	Starts printing the test ticket. SEE SECTION 11.

12.3 Readings → Smoke Test



- Measure the carbon black using the specific optional kit.
- Enter the values found.
- The values of the carbon black that you want to save must be acquired before saving the analyses.
- To join the values of the smoke test to the measurements of the current analysis use the '  ' function.
- To print the ticket with the measurement of the smoke test, activate the '  ' function.
- It is possible to delete the values of the carbon black acquired in the memory by overwriting them by activating the '  ' function again.
- After saving the smoke test values, to carry out the combustion analysis, press the key '  '.





KEY	FUNCTION
	Activate the context keys shown on the display.
	Sets the "soot number" found by the device when measuring the smoke
	Returns to the previous screen.

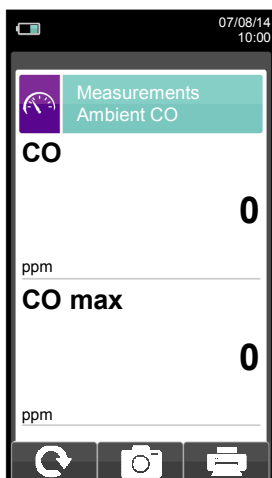

CONTEXT KEY	FUNCTION
	Enters the modification mode for the selected parameter.
	Confirms the value entered.
	Saves, in the memory selected in the "Select Memory" menu, the values entered.
	Starts printing the ticket. SEE SECTION 11.



12.4 Readings → Ambient CO



It is recommended to perform the autozero in the fresh, clean air, so that the ambient CO measurement is correct. It is advisable to turn on the instrument and wait for the autozero completion outside the area where the test is being performed.

- The values of the ambient CO that you want to save must be acquired before saving the analyses.
- To join the values of the ambient CO to the measurements of the current analysis use the " " function.
- To print the ticket with the measurement of the ambient CO, activate the " " function
- It is possible to delete a draft value acquired by the memory by overwriting it by activating the " " function again.
- After saving the CO Test values, to carry out the combustion analysis, press the key " ".

KEY	FUNCTION
	Activate the context keys shown on the display.
	Returns to the previous screen.

CONTEXT KEY	FUNCTION
	Updates the measurement.
	Saves, in the memory selected in the "Select Memory" menu, the data acquired.
	Starts printing the ticket. SEE SECTION 11.

12.5 Readings → Temperature

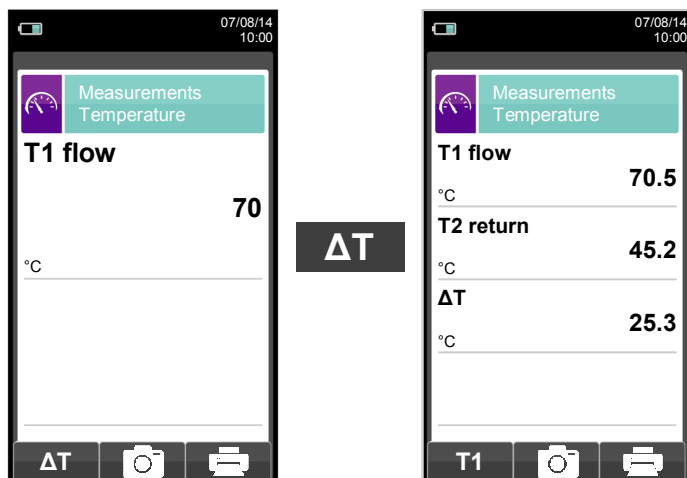

KEY	FUNCTION
	Activate the context keys shown on the display.
	Returns to the previous screen.

CONTEXT KEY	FUNCTION
	Accesses the acquisition of the temperature difference between the supply water (measured by the probe connected to the connector T1 of the device) and the return water (measured by the probe connected to the connector T2 of the device).
	Goes back to the visualisation of the supply water temperature.
	Saves, in the memory selected in the "Select Memory" menu, the data acquired.
	Starts printing the ticket. SEE SECTION 11.

12.6 Readings → Pressure



← Measurement of the differential pressure by means of the internal pressure sensor.



← Measurement of the pressure by means of an external draft gauge.

KEY	FUNCTION
	Activate the context keys shown on the display.
	Returns to the previous screen.

CONTEXT KEY	FUNCTION
	Performs pressure zeroing.
	Saves, in the memory selected in the "Select Memory" menu, the data acquired.
	Starts printing the ticket. SEE SECTION 11.

12.7 Readings → Tightness test

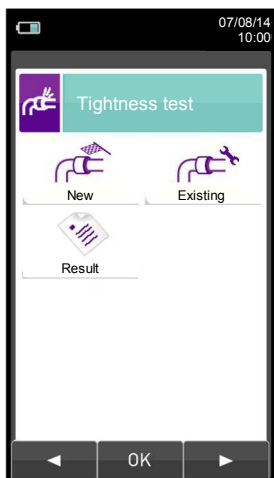

KEY	FUNCTION
	Activate the context keys shown on the display.
	Returns to the previous screen.

CONTEXT KEY	FUNCTION
	Selects the available parameters.
	Enters in the selected parameter setting.
	Selects the available parameters.

PARAMETER	DESCRIPTION
 New	With this menu it is possible to perform a tightness test, in accordance with UNI 7129, on new systems or systems that have been restored after a repair. SEE SECTION 12.8.
 Existing	With this menu it is possible to perform a tightness test, in accordance with UNI 11137, on existing systems. SEE SECTION 12.9.
 Result	This menu allows the user to view and/or save the last test carried out. SEE SECTION 12.10.

12.7.1 Connecting the tightness test kit to the instrument.

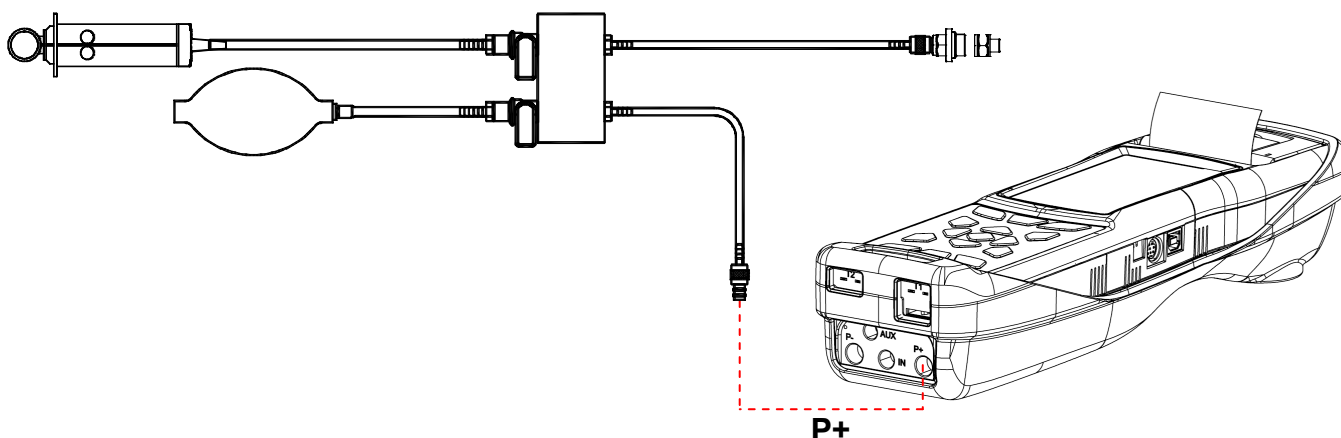

12.8 NEW PIPING: UNI 7129 STANDARD

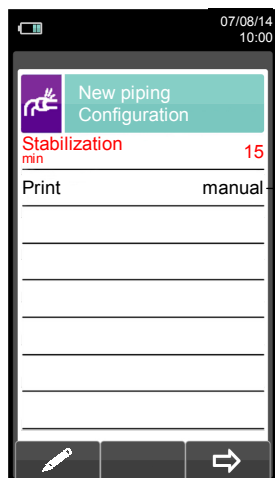

- ➔ Duration of the stabilization phase that can be set between 15 and 240 minutes
- ➔ Printing mode, that can be set as manual or automatic.

KEY	FUNCTION
	Activate the context keys shown on the display.
	Selects line; the selected line is evidenced in red. In edit mode, it sets the desired value.
	Activates the context key located in the left side of the display.
	Returns to the previous screen. When in modify mode cancels the modification just made.

CONTEXT KEY	FUNCTION
	Enters the modification mode for the selected parameter.
	Goes to the next phase of the tightness test.
	Performs pressure zeroing.
	Interrupts the current phase.
	Repeats the tightness test.
	Saves, in the memory selected in the "Select Memory" menu, the data acquired.
	The tightness test has been saved.
	Starts printing the ticket.

Details of the test:

The standard UNI 7129 can be adopted for testing new piping systems or reconditioned ones. This test requires to charge the piping up to a pressure of at least 100 mbar, then wait for a stabilization time of at least 15 minutes required for nulling the thermal effects caused by the test gas compression and finally check for the tightness of the piping by analysing the way the pressure eventually decays against time. This check expects for no difference between two pressure readings performed in 15 minutes and with a manometer having a minimum



resolution of 10 Pa.

The E4500 allows the user to customize the stabilization phase through the following parameter:

WAIT TIME: it is the stabilization time and can be set by the user from 15 to 99 minutes. Please note that the UNI 7129 standard requires that the stabilization takes no less than 15 minutes, However, the wait can be interrupted by activating the context key " although the range is not finished. 

Once the stabilization parameter has been set the user can proceed with the tightness test. By pressing the key relative to the context key '  ', first the test pressure is indicated, as required by law, then you can access a screen which displays the pressure reading of the inputs of the device.

After zeroing the device and putting the system under a pressure of at least 100 hPa, it is possible to start the tightness test by pressing the key relative to the context key '  ', which starts the stabilization phase. In the stabilization screen, the following values are displayed:

- P:** Actual pressure measured by the instrument, in the selected measurement unit.
- ΔP1':** Pressure variation in the last minute, updated every 10 seconds. This value gives a rough indication about the stabilization level reached in the piping system.
- Wait time:** Remaining time before the stabilization phase ends.

Once the stabilization phase is terminated the tightness test is started. This test is performed by observing how the pressure decays in time during a fixed 15 minutes interval, as stated in the applied standard.

During the tightness test phase the following values are displayed:

- P1:** Pressure measured at the beginning of the test.
- P2:** Pressure actually measured by the instrument.
- ΔP:** Pressure variation with respect to the initial value. In case the actual pressure is lower than the initial value (pressure is decreasing) this value has a negative sign.
- Wait time:** Remaining time of the tightness test.

After the tightness test, the results are displayed: the data displayed is as follows:

- P1:** Pressure measured at the beginning of the test.
- P2:** Pressure measured by the device.
- ΔP:** Pressure variation between the last instant and the first instant of the test. If the pressure decreased, it presents a negative value.
- Result:** Reports the test result:
 - tight** when the pressure drop is greater than -10 Pa.
 - leak** when the pressure drop is smaller than -10 Pa. Positive pressure changes are symptom of a temperature change meanwhile the test is performed. Should this happen it is advisable to repeat the entire test.

12.8.1 PERFORMING TIGHTNESS TEST ACCORDING TO UNI 7129

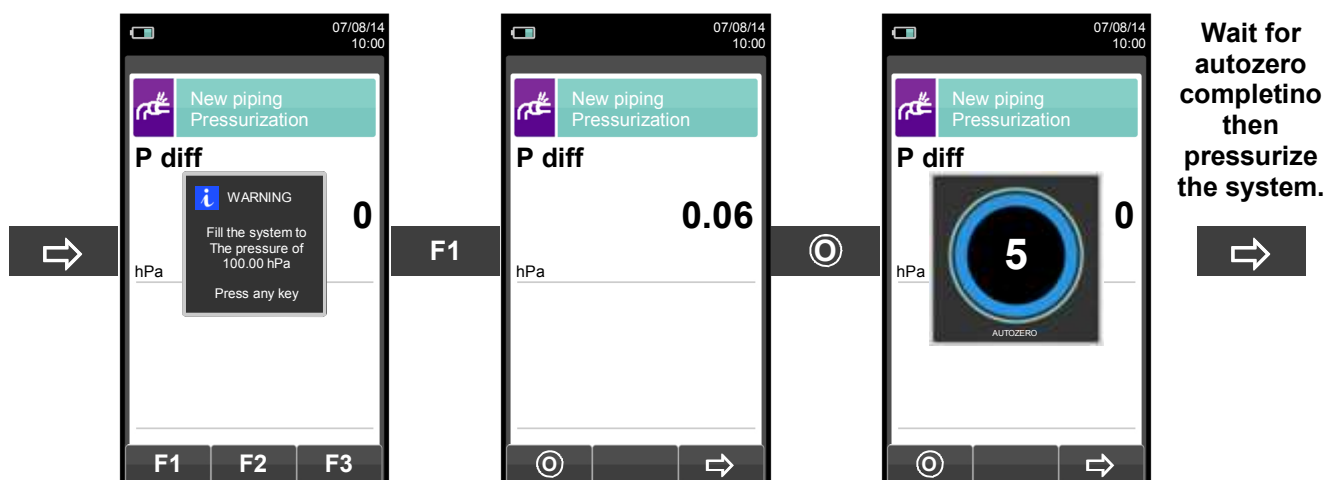
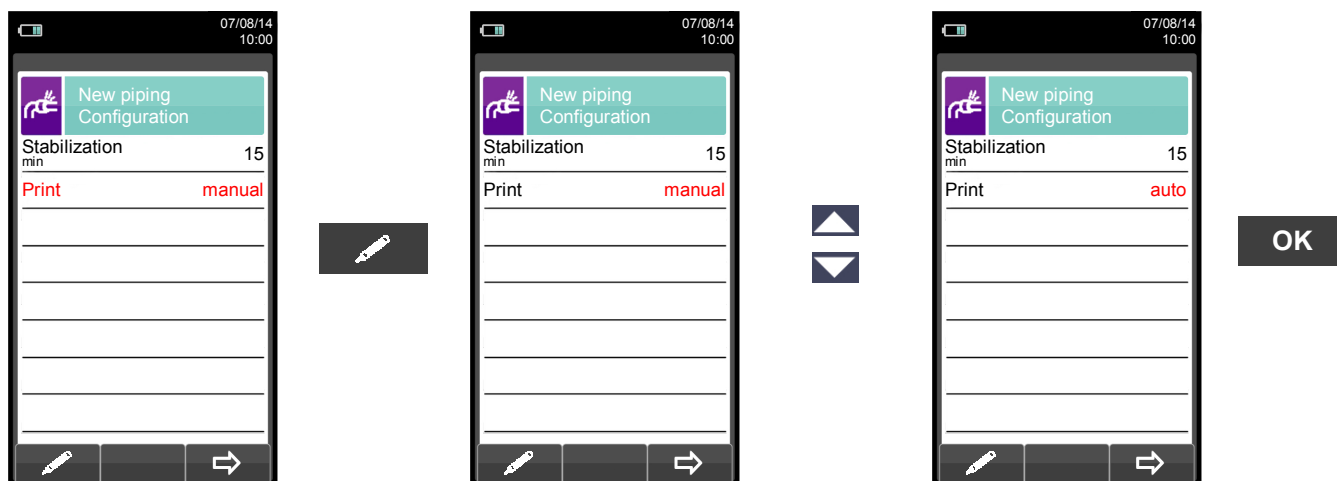
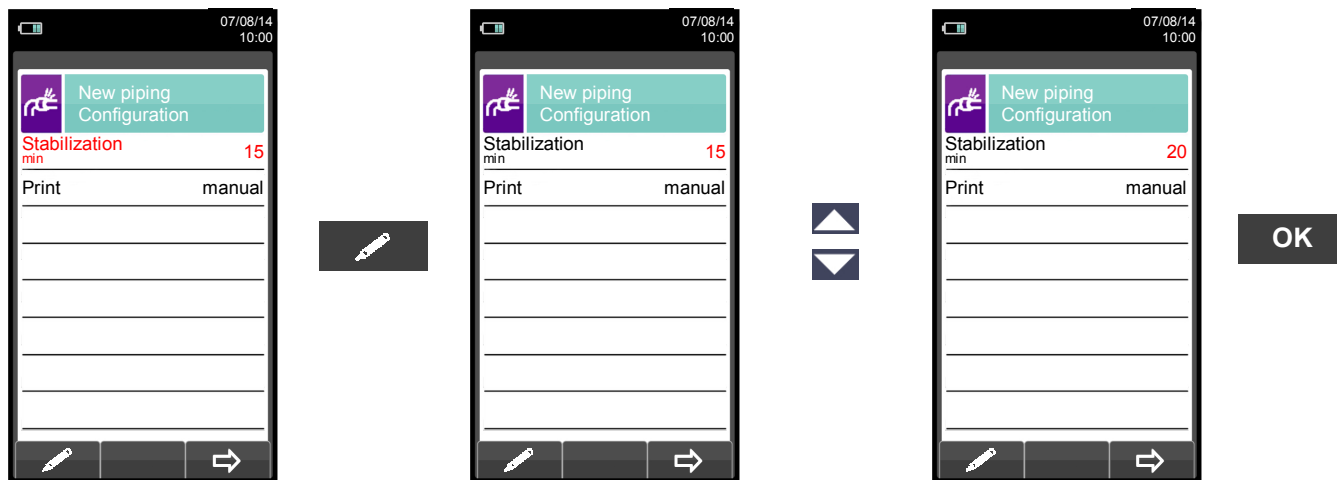



Annotations for the 'New piping Stabilization' screen:

- Pressure of the system.
- Pressure variation in the last minute.
- Waiting time to end the stabilization phase.
- The stabilization phase can be interrupted in any moment.

↓ Automatically

Sequence of operations:

- Initial test configuration screen.
- Pressing the power button (indicated by a power icon) triggers a warning dialog.
- Pressing the F1 key (indicated by an 'F1' icon) proceeds to the 'New piping Pressurization' screen.

↓ Automatically, after 15 minutes.

NOTE: If, while configuring the tightness test the automatic printing mode has been selected, the tightness test is printed automatically.

Instead, if the manual printing mode has been selected (exemplified case), at the end of the tightness test the results are displayed and they can be saved and/or printed.

In this case proceed as follows:

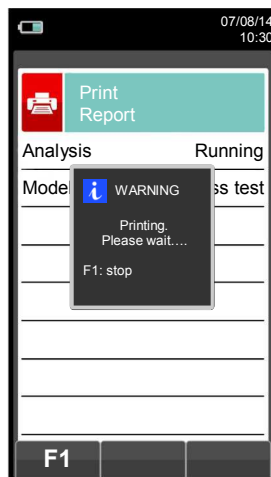
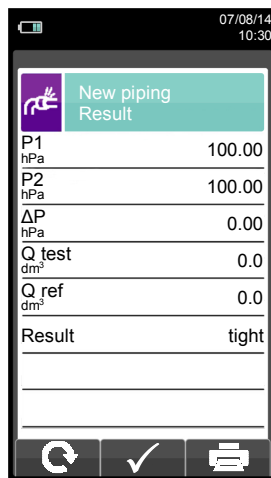
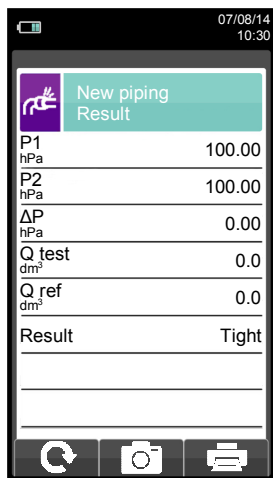

COMPANY Ltd.
 Park Road, 9
 Tel. 800-555-1234
 Oper.: John Smith
 Sign.: _____
 Test according to
 UNI 7129 standard
 Indirect method
 E4500
 Serial: 999989
 Date: 07/08/14
 Time: 10.30
 Stab.duration: 00:15:00
 Test duration: 00:01:00
 Gas Fuel: Natural gas
 Test gas: Natural gas
 V pip 25.0 dm³
 P1 10.05 hPa
 P2 10.03 hPa
 ΔP -0.02 hPa
 Qtest 0.0 dm³/h
 Qref 0.0 dm³/h
 Result: tight



12.9 EXISTING PIPING: UNI 11137 STANDARD

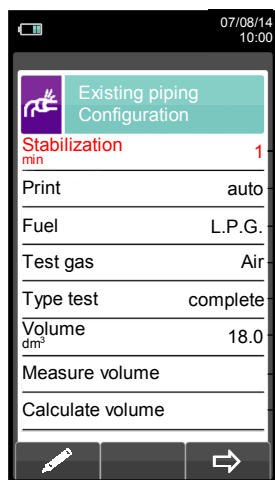

- ▶ Duration of the stabilization phase that can be set between 1 and 240 minutes.
- ▶ Printing mode, that can be set as manual or automatic.
- ▶ Fuel used in the system: L.P.G. - Natural gas.
- ▶ Gas used in the test: Air - fuel.
- ▶ Type of test to perform: preliminary (system volume <math><18.0\text{dm}^3</math>) - Complete.
- ▶ System volume, which can be set if known.
- ▶ Measures the volume of the system.
- ▶ Calculates the volume on the basis of the characteristics of the piping.

KEY	FUNCTION
	Activate the context keys shown on the display.
	Selects line; the selected line is evidenced in red. In edit mode, it sets the desired value.
	Activates the context key located in the left side of the display.
	Returns to the previous screen. When in modify mode cancels the modification just made.

CONTEXT KEY	FUNCTION
	Enters the modification mode for the selected parameter.
	In "Calculate Volume" it adds up one or more sections of piping.
	In "Calculate Volume" it corrects any errors or modifies the current calculation by subtracting one or more sections of piping.
	- Confirms the element entered. - in "Measure Volume" it starts the volume measuring procedure. - in "Calculate Volume" it zeroes the volume acquired.
	Goes to the next phase of the tightness test.
	Performs pressure zeroing.
	Interrupts the current phase.
	- Repeats the tightness test. - In "Measure Volume" it repeats the volume measuring procedure.
	Saves, in the memory selected in the "Select Memory" menu, the data acquired.
	The tightness test has been saved.
	Starts printing the ticket.



Details of the test:

The standard UNI 11137: 2012 can be adopted for testing already existing internal piping systems. This test requires to charge the piping up to the test pressure, then wait for an unspecified stabilization time until the thermal effects caused by the test gas compression are nulled, and then calculate the amount of the possible leakage from the measure of the pressure decays in 1 minute time for Methane and LPG in air and 2.5 minutes for the LPG fuel.

The test pressure should be as close as possible as the reference conditions following explained.

REFERENCE CONDITIONS: According to the combustible gas to be used in the piping, the tightness test must be performed in one of the following reference conditions:

Methane:	Reference pressure for test with supply gas	2200 Pa
	Test pressure with air	5000 Pa
L.P.G.:	Reference pressure for test with supply gas	3000 Pa.
	Test pressure with air	5000 Pa.

Note: The E4500 allows the user to perform the tightness test even with a combustible gas different from the supply gas. Anyway the reference standard does not provide a reference pressure in this situation, so the reference pressure is taken like test gas is the same. Test result should be considered only indicative.

E4500 allows the user to customise the stabilization phase:

STABILIZATION: the stabilization phase duration can be set in the 1 .. 99 minutes range. As the UNI 11137: 2012 standard does not prescribe any stabilization duration, the factory setting for this value is borrowed from the UNI 7129 standard, which requires a minimum stabilization time of 15 minutes.

The waiting time can however be interrupted by activating the context key '  ' even if the interval is not over.

The tightness test performed according to the UNI 11137: 2012 standard requires the input of some data regarding the piping system and the test conditions, as described in the following.

COMBUSTIBLE GAS: consider that the amount of the leakage is strictly related to the nature of the gas under pressure. When the tightness of a piping has to be evaluated it is mandatory to specify the family to which the gas belongs: Methane or L.P.G.



TEST GAS: again the amount of the leakage is related to the nature of the gas under pressure, therefore it is mandatory to specify the type of the gas used: Natural Gas, L.P.G. or air. Please note that the gas used for the test could also be different from the gas to be used in the plant and could even be a not flammable gas.

TYPE OF TEST: An accurate tightness test performed according to the UNI 11137: 2012 standard requires to know the piping volume.

Because this data is often unavailable, The E4500 splits the test from the beginning into two different paths:

Preliminary: valid for systems with a volume under 18 dm³ (litres), the most frequent, where it is not required to enter the value of the volume since it is assumed that the system has a volume of 18 dm³.

Complete: in this case it is necessary to set the volume of the system by entering the numeric value if known, or by calculating the amount as the sum of the contributions of the different sections of piping or, even, by assessing the measurement with a simple procedure that requires the injection into the system of a known amount of gas using a syringe.

If you use volume calculation, for each section of piping it is necessary to set the material, the nominal diameter and the length of the same. The E4500 calculates the volume of the section ("partial volume") and it adds it up, activating the context key '  ' (sum piping), to the calculation of the volume of the system. To correct any errors or to modify the current calculation, the subtraction operation is also allowed by activating the context key '  ' (subtract piping).

When the 'Volume measurement' option is selected instead, the procedure, described also in the flow charts of the tightness test according to UNI 11137: 2012, is described in the following steps:

- Close both valves of the piping kit supplied for the test.
- Connect the syringe to the kit opposite the syringe graduated to the pipe opposite of the kit.







- Press the key relative to the context key ' **OK** '.
- Open the valve on the side where the syringe is connected, take exactly 100 ml (100 cc) of the gas present in the system.
- Wait for the stabilization of the pressure of the system. After a few seconds, the device displays the measured volume. The suggested value can be accepted by pressing the key '  ' and then modified by selecting, in "UNI 11137 Configuration" the line "volume".
It is also possible to repeat the measurement of the volume by pressing the key relative to the interactive function '  '.

Table volumes:

Examples relating to the various lengths of indoor systems, capacity approximately corresponding to 18dm³, depending on the material and the diameter of the fuel gas adduction pipe.

Steel		Copper / Multilayer/ Polyethylene	
Diameter	length (m)	Internal diameter (mm)	length (m)
1/2"	82 (68)	10	228 (190)
3/4"	49 (40)	12	160 (133)
1"	28 (23)	14	116 (97)
1 1/4"	17 (14)	16	90 (75)
		19	64 (53)
		25	37 (31)
		26	34 (28)
		34	20 (17)

Note: When the measurement group can not be excluded from the test, the indicative length of the plant is given in brackets.

Once the stabilization mode has been defined and the required data has been entered, you can proceed with the tightness test. By pressing the key relative to the context key '  ', first the test pressure is indicated, as required by law, then you can access a screen which displays the pressure reading of the inputs of the device. After zeroing the device and putting the system under a pressure of at least 100 hPa, it is possible to start the tightness test by pressing the key relative to the context key '  ', which starts the stabilization phase. In the stabilization screen, the following values are displayed:

- P diff:** Actual pressure measured by the instrument, in the selected measurement unit.
- ΔP 1 min:** Pressure variation in the last minute, updated every 10 seconds. This value gives a rough indication about the stabilization level reached in the piping system.
- Wait time:** Remaining time before the stabilization phase ends.

Once the stabilization phase is terminated the tightness test is started. This test is performed by observing how the pressure decays in time during a fixed 1 minute interval for Methane and LPG in air and 2.5 minutes for the LPG fuel, as stated in the applied standard.

During the tightness test phase the following values are displayed:

- P1:** Pressure measured at the beginning of the test
- P2:** Pressure actually measured by the instrument
- ΔP:** Pressure variation with respect to the initial value. In case the actual pressure is lower than the initial value (pressure is decreasing) this value has a negative sign.
- Wait time:** Remaining time before the Test phase ends.

Once the test has finished, the results are displayed; the data displayed is as follows:

- P1:** Pressure measured at the beginning of the test
- P2:** Pressure measured by the device.



- ΔP:** Pressure variation between the last instant and the first instant of the test. If the pressure decreased, it presents a negative value.
- Q_{test}:** Is the calculated leakage measured in dm³/h according to the conditions under which the test has been performed, i.e. the gas used for the test as well as the final pressure measured during the test.
- Q_{ref}:** is the calculated leakage measured in dm³/h according to the reference conditions described in the standard, it is related to the gas to be used in the piping as well as to the reference pressure.
- Result:** is the result of the tightness test.
- Compliant (piping suitable for operation):** when the leakage flow calculated in the reference conditions is not greater than 1 dm³/h for methane and not greater than 0,4 dm³/h for LPG the system is authorized to operate without restrictions or intervention.
- Compl. 30 DD (piping temporarily suitable for operation):** when the leakage flow calculated in the reference conditions is included in the range $1 \text{ dm}^3/\text{h} < Q_{\text{ref}} \leq 5 \text{ dm}^3/\text{h}$ for methane and in the range $0,4 \text{ dm}^3/\text{h} < Q_{\text{ref}} \leq 2 \text{ dm}^3/\text{h}$ for LPG. The system is authorized to operate only for the time needed for the maintenance of the pipe in order to fix the leakage problem, and in any case for no more than 30 days after the testing day. Once the fixing has been completed the piping must be tested again for its tightness according to the UNI 7129 standard.
- Non compliant (not suitable for operation):** when the leakage flow is greater than 5 dm³/h for methane and greater than 2 dm³/h for LPG. In this situation the measured leakage is such that the piping is not suitable for operation and must immediately be placed out of order. Once the leakage problem has been fixed the piping must be tested again for its tightness according to the UNI 7129 standard.

12.9.1 CONFIGURATION OF TIGHTNESS TEST ACCORDING TO UNI 11137



07/08/14 10:00

Existing piping Configuration

Stabilization min 1

Print manual

Fuel L.P.G.

Test gas Air

Type test preliminary

Volume dm³ <18.0



07/08/14 10:00

Existing piping Configuration

Stabilization min 1

Print manual

Fuel L.P.G.

Test gas Air

Type test preliminary

Volume dm³ <18.0



07/08/14 10:00

Existing piping Configuration

Stabilization min 2

Print manual

Fuel L.P.G.

Test gas Air

Type test preliminary

Volume dm³ <18.0



07/08/14 10:00

Existing piping Configuration

Stabilization min 1

Print manual

Fuel L.P.G.

Test gas Air

Type test preliminary

Volume dm³ <18.0



07/08/14 10:00

Existing piping Configuration

Stabilization min 1

Print manual

Fuel L.P.G.

Test gas Air

Type test preliminary

Volume dm³ <18.0



07/08/14 10:00

Existing piping Configuration

Stabilization min 1

Print auto

Fuel L.P.G.

Test gas Air

Type test preliminary

Volume dm³ <18.0



07/08/14 10:00

Existing piping Configuration

Stabilization min 1

Print auto

Fuel L.P.G.

Test gas Air

Type test preliminary

Volume dm³ <18.0



07/08/14 10:00

Existing piping Configuration

Stabilization min 1

Print auto

Fuel L.P.G.

Test gas Air

Type test preliminary

Volume dm³ <18.0



07/08/14 10:00

Existing piping Configuration

Stabilization min 1

Print auto

Fuel Natural gas

Test gas Air

Type test preliminary

Volume dm³ <18.0





Existing piping Configuration	
Stabilization min	1
Print	manual
Fuel	L.P.G.
Test gas	Air
Type test	preliminary
Volume dm ³	<18.0



Existing piping Configuration	
Stabilization min	1
Print	manual
Fuel	L.P.G.
Test gas	Air
Type test	preliminary
Volume dm ³	<18.0



Existing piping Configuration	
Stabilization min	2
Print	manual
Fuel	L.P.G.
Test gas	Fuel
Type test	preliminary
Volume dm ³	<18.0



Existing piping Configuration	
Stabilization min	1
Print	manual
Fuel	L.P.G.
Test gas	Air
Type test	preliminary
Volume dm ³	<18.0



Starts the tightness test for systems up to 18 dm³ (SEE SECTION 12.9.2).



Existing piping Configuration	
Stabilization min	1
Print	manual
Fuel	L.P.G.
Test gas	Air
Type test	preliminary
Volume dm ³	<18.0



Existing piping Configuration	
Stabilization min	1
Print	auto
Fuel	L.P.G.
Test gas	Air
Type test	full
Volume dm ³	18.0
Measure volume	
Calculate volume	



Existing piping Configuration	
Stabilization min	1
Print	auto
Fuel	L.P.G.
Test gas	Air
Type test	full
Volume dm ³	18.0
Measure volume	
Calculate volume	



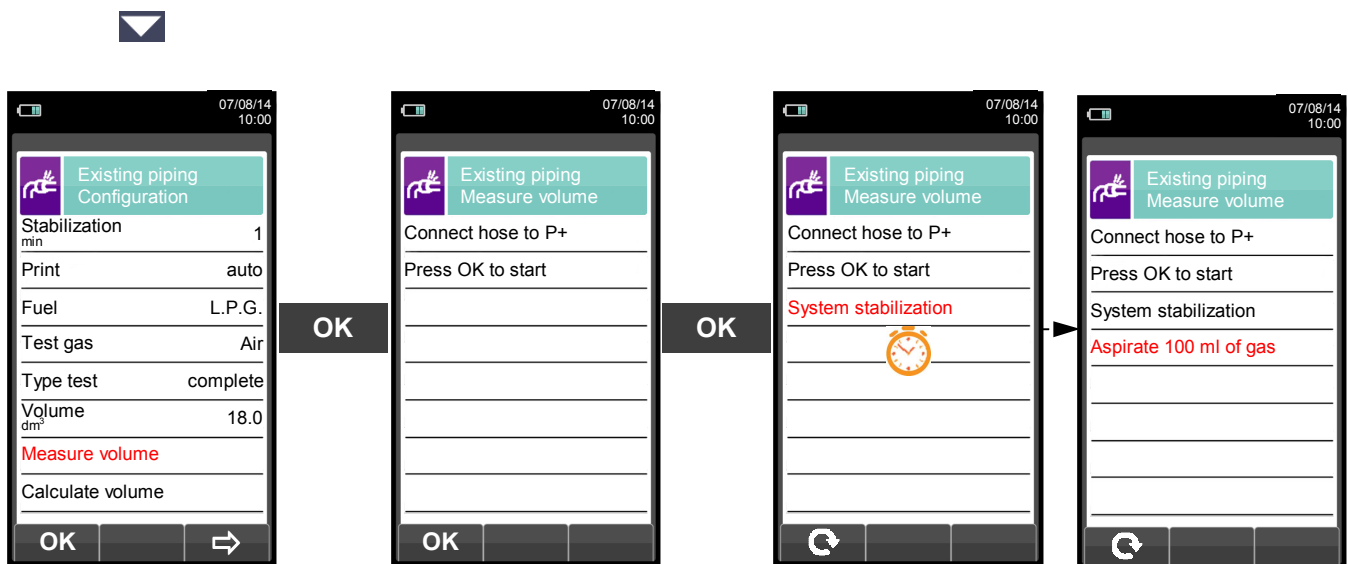
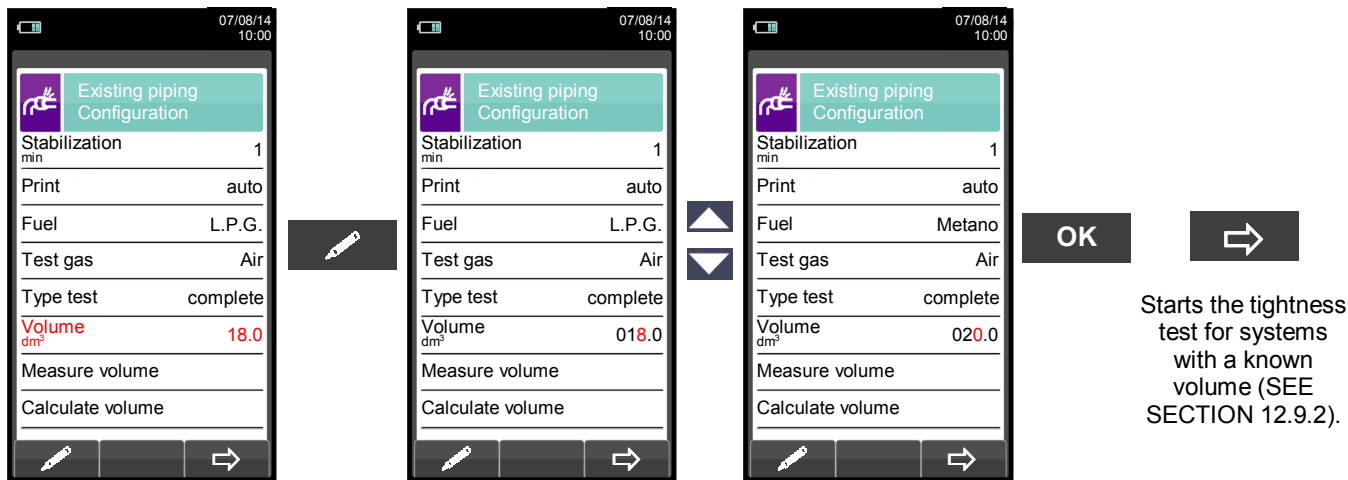

Alternatively



Take, with the syringe (that comes with the tightness test kit), 100 ml of gas. If the volume measuring procedure of the system ends correctly, the E4500 automatically displays the measured volume, otherwise it requires another test.

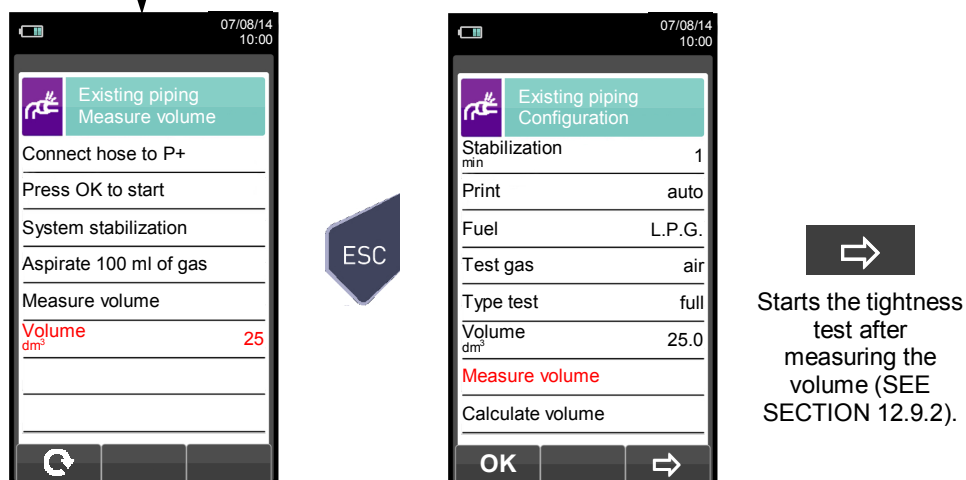

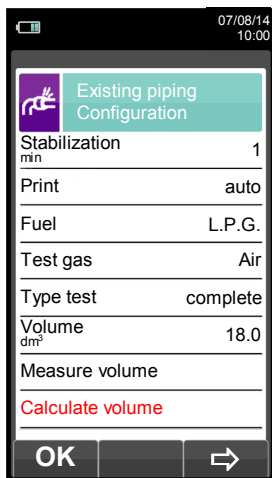

OK

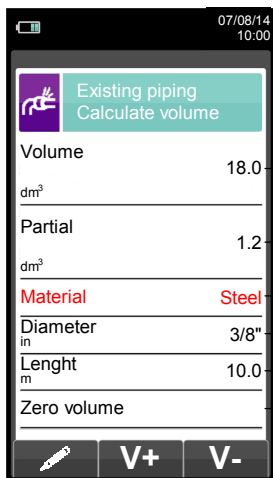

- Total volume acquired.
- Volume of the section of piping set below.
- Sets the material of the section of piping.
- Sets the nominal diameter of the section of piping.
- Sets the length of the section of piping.
- Zeroes the volume previously acquired.

V+

Adds up the volume of the section of piping entered.

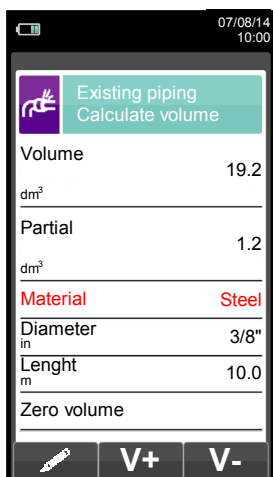

ESC

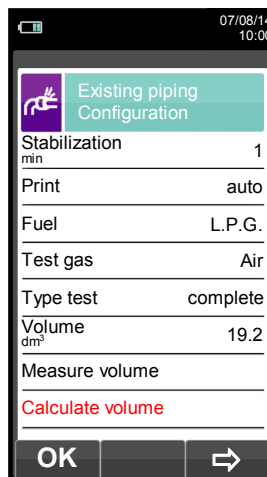

Starts the tightness test (see section 12.9.2).

V-

Subtracts the volume of the section of piping entered.

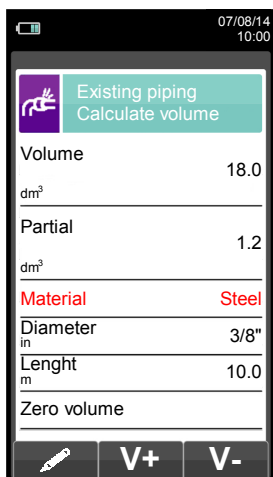

ESC

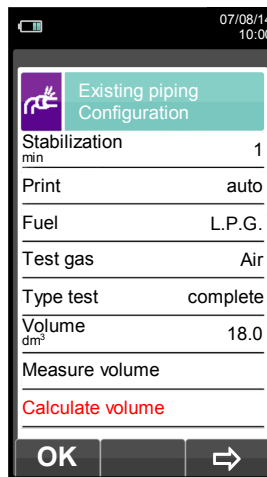

Starts the tightness test (see section 12.9.2).

12.9.2 PERFORMING THE TIGHTNESS TEST ACCORDING TO UNI 11137

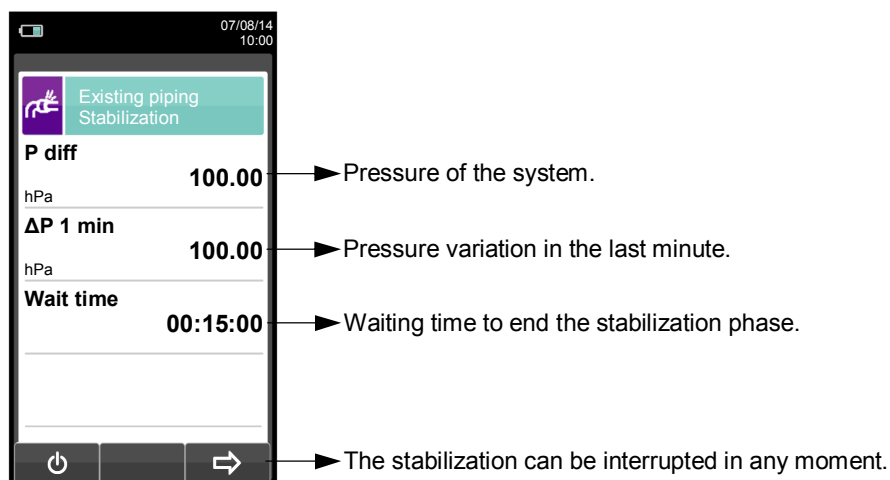
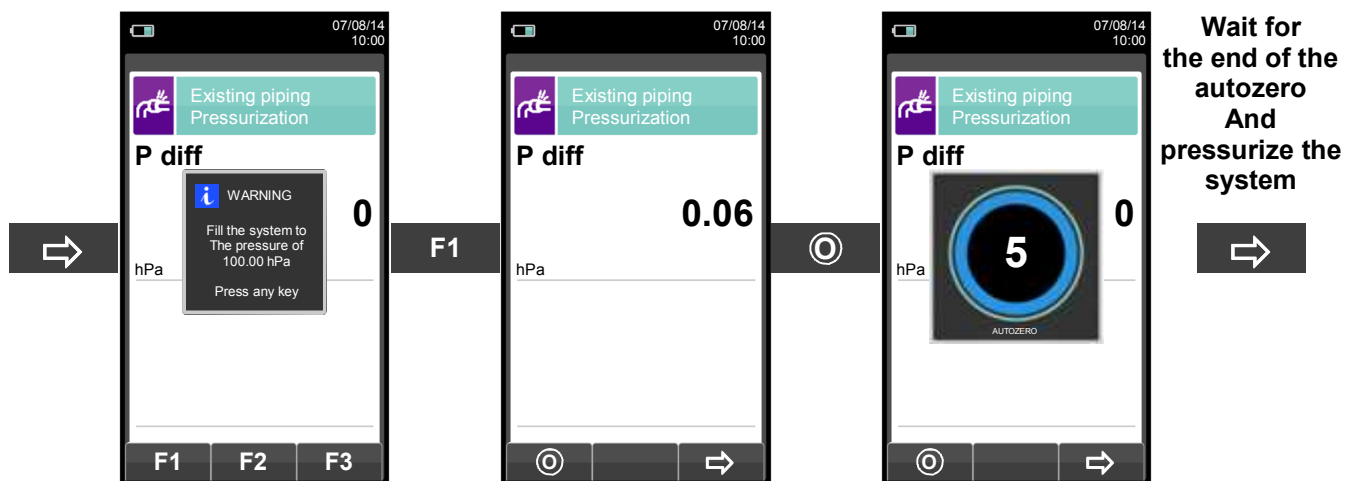

➡ ↓ **Automatically**

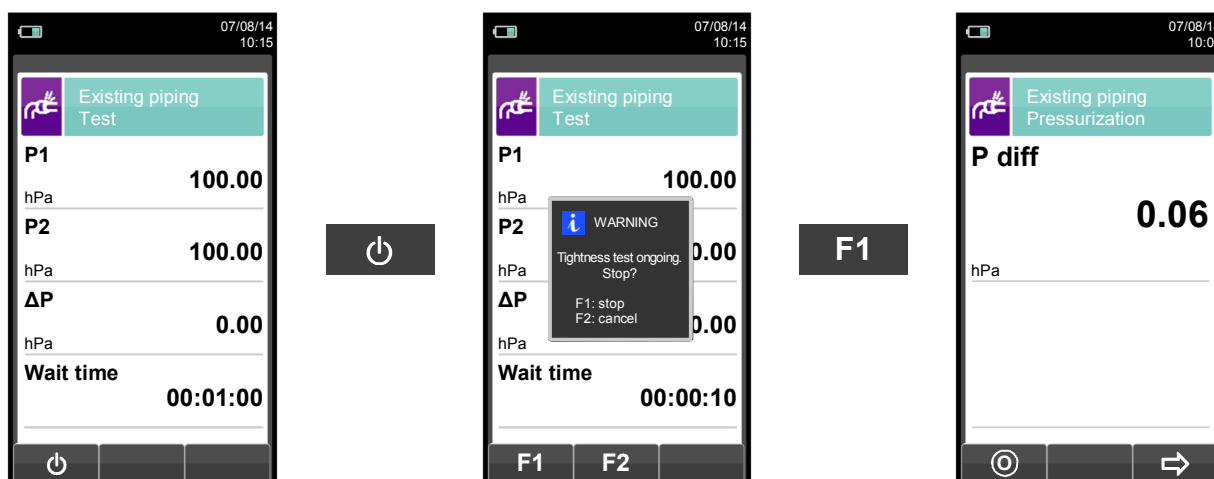

↓ **Automatically, after 1 minute.**



NOTE: If, while configuring the tightness test the automatic printing mode has been selected, the tightness test is printed automatically.

Instead, if the manual printing mode has been selected (exemplified case), at the end of the tightness test the results are displayed and they can be saved and/or printed.

In this case proceed as follows:

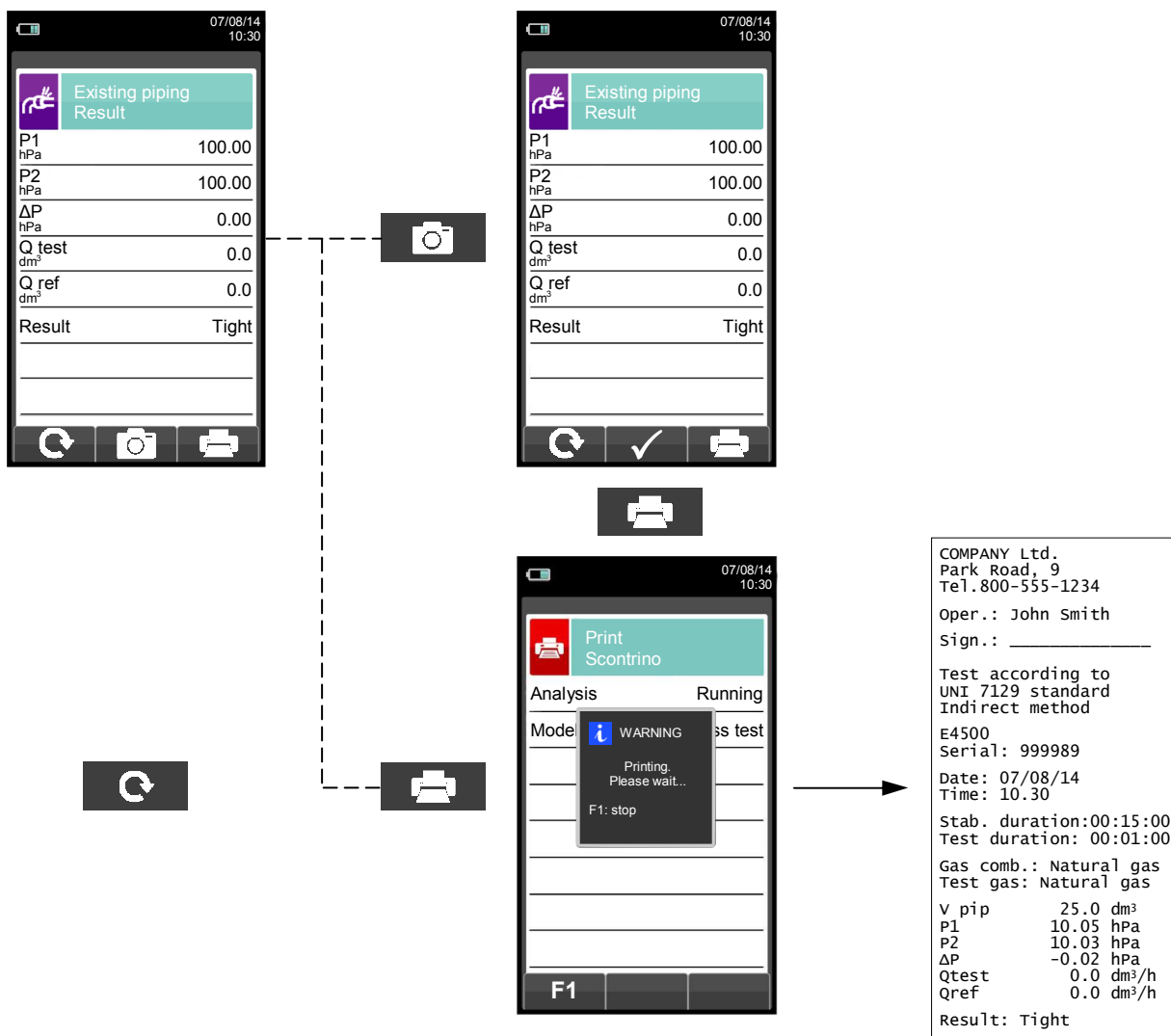



12.10 RESULTS OF THE TIGHTNESS TEST

07/08/14
10:30

Existing piping
Result

P1 hPa	100.00
P2 hPa	100.00
ΔP hPa	0.00
Q test dm ³	0.0
Q ref dm ³	0.0
Result	Tight

Esc



07/08/14
10:30

Existing piping
Result

P1 hPa	100.00
P2 hPa	100.00
ΔP hPa	0.00
Q test dm ³	0.0
Q ref dm ³	0.0
Result	Tight

Esc

The tightness test is saved in the selected memory.



Esc



07/08/14
10:30

Print Report

Analysis Running

Mode WARNING ss test

Printing. Please wait...
F1: stop

F1

COMPANY Ltd.
Park Road, 9
Tel. 800-555-1234

Oper.: John Smith
Sign.: _____

Test according to
UNI 7129 standard
Indirect method

E4500
Serial: 999989

Date: 07/08/14
Time: 10.30

Stab. duration:00:15:00
Test duration :00:01:00

Comb. gas: Natural gas
Test gas : Natural gas

V pip 25.0 dm³
P1 10.05 hPa
P2 10.03 hPa
ΔP -0.02 hPa
Qtest 0.0 dm³/h
Qref 0.0 dm³/h

Result: tight

07/08/14
10:00

Measurements
Pressure

New Existing

Result

◀ OK ▶

12.11 Measurements → External probe



Not available.

13.1 FLUE GAS ANALYSIS



To perform complete flue gas analysis, follow the instructions below.



SOME IMPORTANT WARNINGS TO CONSIDER DURING THE COMBUSTION ANALYSIS ARE LISTED BELOW:

FOR A CORRECT ANALYSIS NO AIR MUST FLOW INTO THE PIPE FROM OUTSIDE DUE TO A BAD TIGHTENING OF THE POSITIONING CONE OR A LEAK IN THE PIPELINE.

THE GAS PIPE MUST BE CHECKED IN ORDER TO AVOID ANY LEAKAGES OR OBSTRUCTIONS ALONG THE PATH.

THE CONNECTORS OF THE GAS SAMPLING PROBE AND OF THE CONDENSATE FILTER MUST BE WELL CONNECTED TO THE INSTRUMENT.

KEEP THE CONDENSATE TRAP IN THE VERTICAL POSITION DURING THE ANALYSIS; A WRONG POSITIONING MAY CAUSE CONDENSATE INFILTRATIONS IN THE INSTRUMENT AND THUS DAMAGE THE SENSORS.

DO NOT PERFORM ANY MEASUREMENT WHEN THE FILTER IS REMOVED OR DIRTY IN ORDER TO AVOID ANY RISK OF IRREVERSIBLE DAMAGES ON SENSORS.

13.1.1 Switching on the instrument and auto-calibration

Press the On/Off key to switch on the instrument - an introductory screen will appear. After a couple of moments the instrument will zero itself and will state that the sample probe should not be inserted in the stack.

In case the instrument is equipped with the electrovalve for automatic auto-zeroing, it will ask for the insertion of the gas probe in the stack. On the other hand if the instrument has not the electrovalve, it will require not to insert the gas probe in the stack.

In the latter it is important that the sample probe is not inside the stack since, during auto-calibration, the instrument draws fresh air from the environment and detects the zero value of the O₂, CO and NO sensors, the details of which are then memorized and used for reference during the analysis. It is equally important that this phase is performed in a fresh-air environment.

The pressure sensor is also zeroed during auto-calibration.

13.1.2 Inserting the probe inside the stack

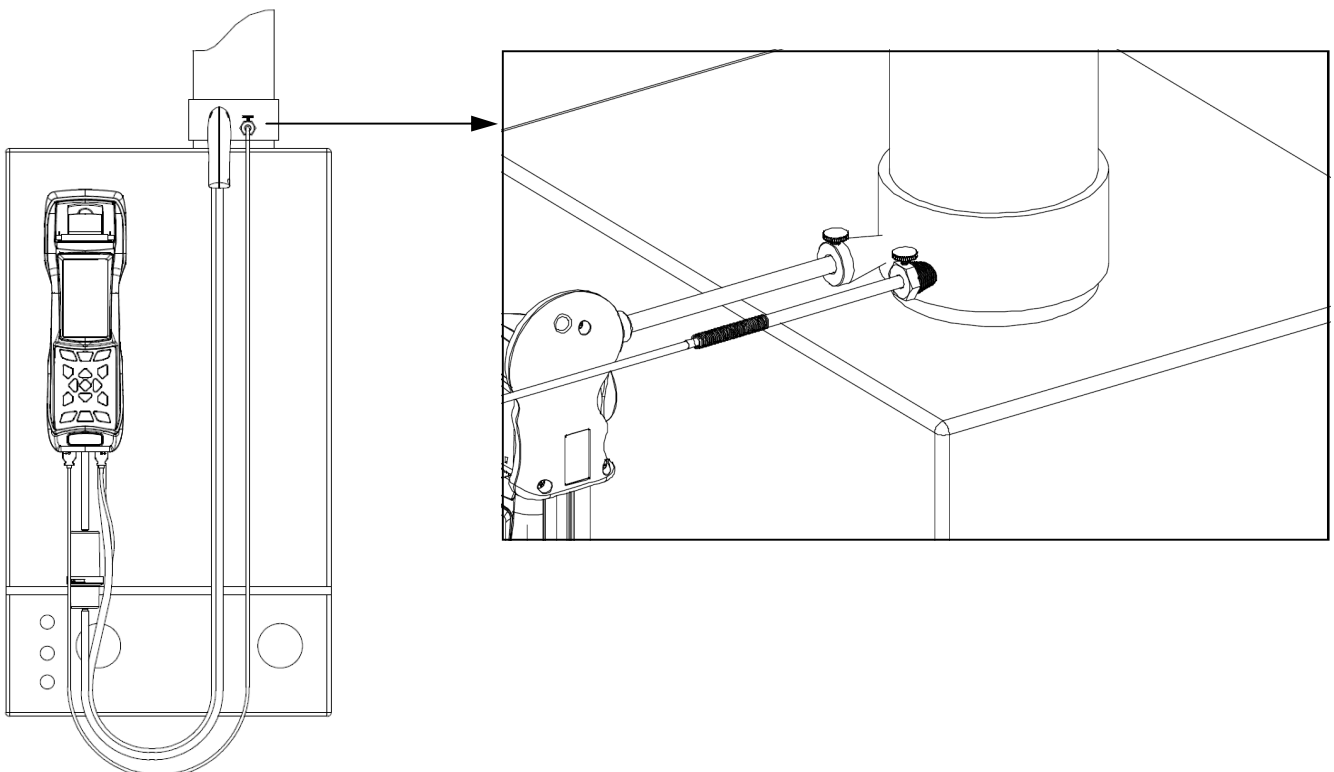



When auto-calibration is complete the instrument will instruct the user to insert the sample probe that has been previously connected to the relative input on the instrument, and the analysis screen will appear automatically. In order for the probe to be inserted at the right point within the stack, its distance from the boiler has to be twice the diameter of the stack pipe itself or, if this is not possible, must comply with the boiler manufacturer's instructions.

In order to position the probe correctly, a reliable support must be provided by drilling a 13/16 mm hole in the manifold (unless already present) and screwing in the positioning cone provided with the probe - in this way no air is drawn from the outside during sampling.

The screw on the cone allows the probe to be stopped at the right measuring depth - this usually corresponds to the center of the flue pipe. For greater positioning accuracy, the user may insert the probe gradually into the pipe until the highest temperature is read. The exhaust pipe must be inspected before carrying out the test, so as to ensure that no constrictions or losses are present in the piping or stack.

13.1.3 Flue Gas Analysis

After the sample probe has been inserted in the stack and the combustion air temperature probe (if used) has been inserted in the relative sample manifold, if the instrument has not been configured during auto-calibration, the following data must be configured:

Memory: use this submenu to define the memory in which the test data and client details are to be stored.

Fuel: the user will be asked to define the type of fuel used by the plant.

Operator: this is where the name of the test operator can be entered.

Mode: by entering this submenu, the user can determine the analysis mode - manual or automatic.

If automatic mode is chosen, the reading duration of each and every test must be set, besides the printing mode - manual or automatic. When flue gas analysis begins, the instrument will perform and memorize the three tests automatically, at the respective intervals set (at least 120 sec. according to UNI 10389-1).

At the end of each test the instrument will emit an audible alarm (one "beep" after the first test, two "beeps" after the second test and three "beeps" after the third test).

At this point, when all three tests are over, if "Manual Printing" has been chosen the instrument will display the average of the three tests with the possibility of recalling the individual values.

If desired, the user can then print the relative data (total, complete, etc....). On the contrary, if "Automatic Printing" was selected, the instrument will print the test data automatically, based on the current print settings, without displaying the average test values.

Caution: when in automatic mode Draft, Smoke and ambient CO (NO) measurements must be taken before initiating the flue gas analysis.

If, on the other hand, manual analysis mode is chosen, flue gas analysis will proceed manually (please see relative Flow Chart). In this case the print settings and automatic test duration will not be considered.

At this point manual analysis may commence, first waiting at least two minutes until the displayed values stabilise: The user can then proceed with data storage, if required, or print the analysis report directly.

The latter will be printed in the format set beforehand.

When all three tests are over, the user can recall the average analysis screen containing all the data necessary for compiling the maintenance log of the boiler or plant.

In both modes, automatic and manual, the displayed data of the pollutants CO / NO / NO_x can be translated into normalised values (with reference to the concentration of O₂ previously set).

13.1.4 End of Analysis

At the end of the combustion analysis, carefully remove the sample probe and remote air temperature probe, if used, from their relative ducts, taking care not to get burnt.

Switch off the instrument by pressing the On/Off key.

At this point, if the instrument has detected a high concentration of CO and/or NO, a self-cleaning cycle will be initiated during which the pump will draw fresh outside air until the gas levels drop below acceptable values.

At the end of the cycle (lasting no longer than 3 min.) the instrument will switch itself off automatically.

13.2 FLUE GAS ANALYSIS - PRELIMINARY OPERATIONS



Insert the gas sample probe in the chimney:

Models (with automatic autozero solenoid) E4500

Do not insert the gas sample probe in the chimney:

Models (without solenoid) 1500

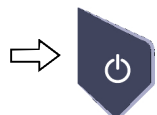

Hold down for a few seconds

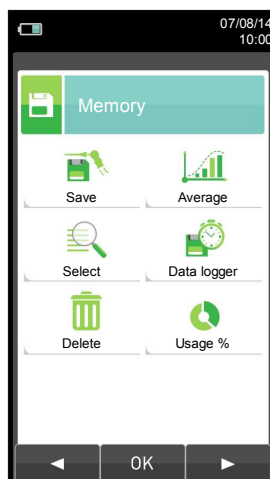
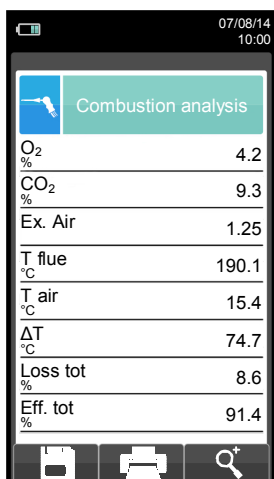
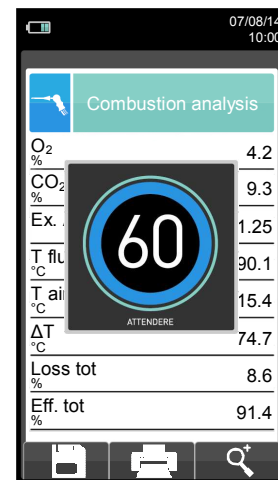
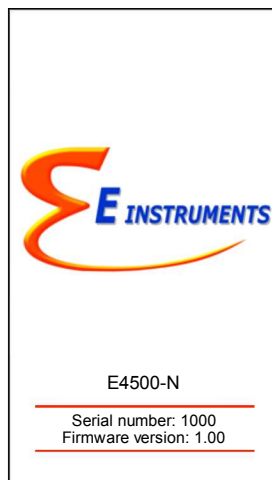

PARAMETERS TO SET BEFORE PROCEEDING (SEE SECTION 10.0):

Select Data logger

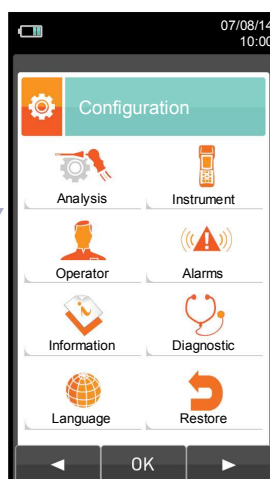

PARAMETERS TO SET BEFORE PROCEEDING (SEE SECTION 9.0):

Analysis Operator

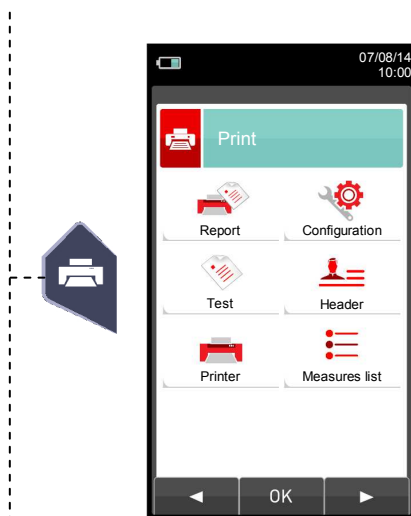

PARAMETERS TO SET BEFORE PROCEEDING (SEE SECTION 11.0):

**Configuration
Header
Measures list**

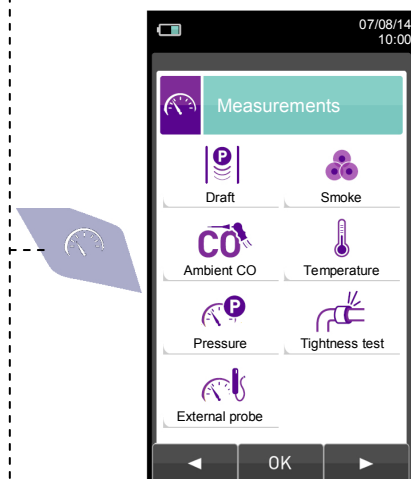

ACQUIRE THE FOLLOWING MEASUREMENTS BEFORE PROCEEDING WITH THE COMBUSTION ANALYSIS (Section 12.0):



In you don't, the measurements will not be printed with the combustion analysis.

**Draft
Smoke
Ambient CO
Temperature
Pressure**

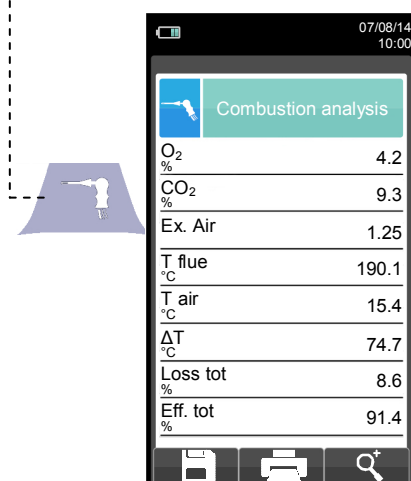

PRESS THE KEY '  ':

It starts saving the current analysis according to the set mode.

- Manual See section 11.2.1
- UNI 10389 See section 11.2.2
- BlmSchV See section 11.2.3
- data logger See section 11.2.4

PRESS THE KEY '  ':

It starts the printing on test ticket of the current analysis; additional measurements are also printed, if they are present in the memory.

13.3 PERFORMING COMBUSTION ANALYSIS - MANUAL MODE



Combustion analysis	
O ₂ %	4.2
CO ₂ %	9.3
Ex. Air	1.25
T flue °C	190.1
T air °C	15.4
ΔT °C	74.7
Loss tot %	8.6
Eff. tot %	91.4



Memory Save	
Mode	manual
Memory	12
Analysis	1

OK
Saves analysis number 1

Combustion analysis	
O ₂ %	4.2
CO ₂ %	9.3
Ex. Air	1.25
T flue °C	190.1
T air °C	15.4
ΔT °C	74.7
Loss tot %	8.6
Eff. tot %	91.4



Memory Save	
Mode	manual
Memory	12
Analysis	2

OK
Saves analysis number 2

Combustion analysis	
O ₂ %	4.2
CO ₂ %	9.3
Ex. Air	1.25
T flue °C	190.1
T air °C	15.4
ΔT °C	74.7
Loss tot %	8.6
Eff. tot %	91.4



Memory Save	
Mode	manual
Memory	12
Analysis	3

OK
Saves analysis number 2

Combustion analysis	
O ₂ %	4.2
CO ₂ %	9.3
Ex. Air	1.25
T flue °C	190.1
T air °C	15.4
ΔT °C	74.7
Loss tot %	8.6
Eff. tot %	91.4



Memory	
Save	Average
Select	Data logger
Delete	Usage %

Recalls the average analysis.



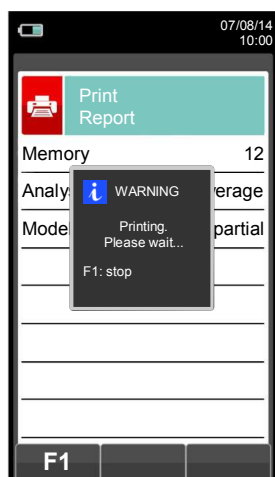
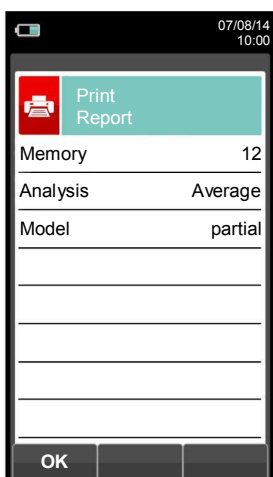
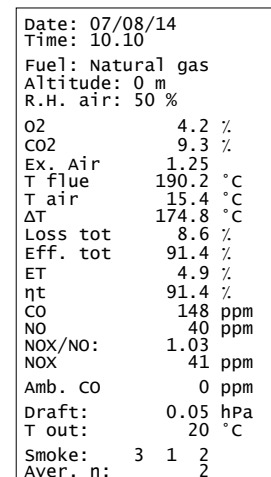
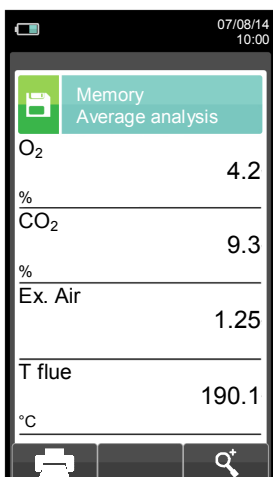
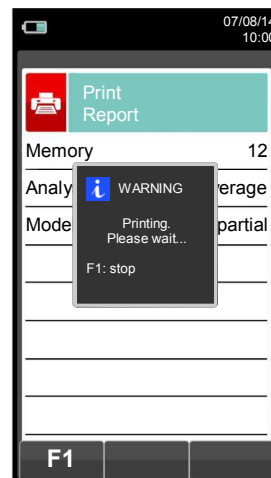
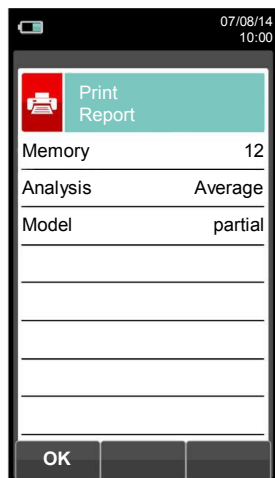
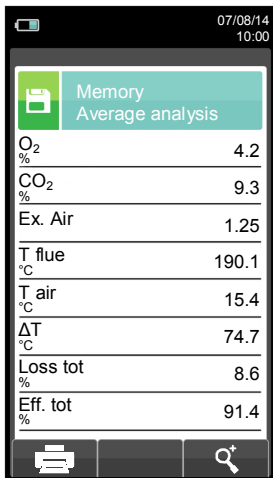

13.4 PERFORMING THE COMBUSTION ANALYSIS- UNI 10389 MODE



Automatically saves the first sample when the set time is over.

Automatically saves the second sample when the set time is over.

Automatically saves the third sample when the set time is over.

NOTE: If, while configuring the tightness test the automatic printing mode has been selected, the tightness test is printed automatically.

Instead, if the manual printing mode has been selected (exemplified case), at the end of the tightness test the results are displayed and they can be saved and/or printed. In this case proceed as follows:

Date: 07/08/14
Time: 10.10
Fuel: Natural gas
Altitude: 0 m
R.H. air: 50 %
O2 4.2 %
CO2 9.3 %
Ex. Air 1.25 %
T flue 190.2 °C
T air 15.4 °C
ΔT 174.8 °C
Loss tot 8.6 %
Eff. Tot 91.4 %
ET 4.9 %
ηt 91.4 %
CO 148 ppm
NO 40 ppm
NOX/NO: 1.03
NOX 41 ppm
Amb. CO 0 ppm
Draft: 0.05 hPa
T out: 20 °C
Smoke: 3 1 2
Aver. n: 2

13.5 PERFORMING THE COMBUSTION ANALYSIS - BlmSchV MODE



Automatically saves the first sample when the set time is over.

Parameter	Value
O ₂ %	4.2
CO ₂ %	9.3
Ex. Air	1.25
T flue °C	190.1
T air °C	15.4
ΔT °C	74.7
Loss tot %	8.6
Eff. tot %	91.4

Automatically saves the second sample when the preset time interval has elapsed and so on until the last sample.

Once the flue gas analysis is completed the instrument saves the average value of the samples taken.

Print Report

WARNING: Printing. Please wait... F1: stop

NOTE: If, while configuring the tightness test the automatic printing mode has been selected, the tightness test is printed automatically.

Instead, if the manual printing mode has been selected (exemplified case), at the end of the tightness test the results are displayed and they can be saved and/or printed. In this case proceed as follows:

Print Report

WARNING: Printing. Please wait... F1: stop

Parameter	Value
O ₂ %	4.2
CO ₂ %	9.3
Ex. Air	1.25
T flue °C	190.1
T air °C	15.4
ΔT °C	74.7
Loss tot %	8.6
Eff. Tot %	91.4
ET	4.9 %
ηt	91.4 %
CO	148 ppm
NO	40 ppm
NOX/NO:	1.03
NOX	41 ppm
CO amb	0 ppm
Draft:	0.05 hPa
T out:	20 °C
Smoke:	3 1 2
Aver. n:	2

13.6 PERFORMING THE COMBUSTION ANALYSIS - data logger MODE



The first screenshot shows the 'Combustion analysis' screen with the following data:

O ₂ %	4.2
CO ₂ %	9.3
Ex. Air	1.25
T flue °C	190.1
T air °C	15.4
ΔT °C	74.7
Loss tot %	8.6
Eff. tot %	91.4

The second screenshot shows the 'Memory Save' dialog with 'Mode' set to 'data logger', 'Memory' at 1, 'Samples' at 10, and 'Interval' at 60. An 'OK' button is visible.

The third screenshot shows the 'Combustion analysis data logger' screen with the same data as the first screenshot. The bottom bar shows '1' and '60'. An arrow points to the right with the text: **Automatically saves the first sample when the set time is over.**

The first screenshot shows the 'Combustion analysis data logger' screen with the same data as the previous step. The bottom bar shows '2' and '60'. An arrow points to the right with the text: **Automatically saves the second sample when the set time is over and so on until the last sample.**

The second screenshot shows the 'Print Report' screen with a 'WARNING' dialog box overlaid. The dialog says 'Printing. Please wait... F1: stop'. The background shows 'Memory' at 1 and 'Analysis' at 'Average'. An arrow points down from this screen to the next section.

NOTE: If, while configuring the tightness test the automatic printing mode has been selected, the tightness test is printed automatically.

Instead, if the manual printing mode has been selected (exemplified case), at the end of the tightness test the results are displayed and they can be saved and/or printed. In this case proceed as follows:

The first screenshot shows the 'Memory Average analysis' screen with the same data as the previous steps. A printer icon is visible in the bottom bar.

The second screenshot shows the 'Print Report' screen with 'Memory' at 1, 'Analysis' at 'Average', and 'Model' at 'partial'. An 'OK' button is visible.

The third screenshot shows the 'Print Report' screen with the 'WARNING' dialog box overlaid. The dialog says 'Printing. Please wait... F1: stop'. An arrow points to the right towards the final report.

The final report is displayed as follows:

```

Date: 07/08/14
Time: 10.10
Fuel: Natural gas
Altitude: 0 m
R.H. air: 50 %
O2          4.2 %
CO2         9.3 %
Ex. Air     1.25
T flue     190.2 °C
T air      15.4 °C
ΔT         174.8 °C
Loss tot   8.6 %
Eff. tot   91.4 %
ET         4.9 %
ηt         91.4 %
CO         148 ppm
NO         40 ppm
NOX/NO:    1.03
NOX        41 ppm
Amb. CO    0 ppm
Draft:     0.05 hPa
T out:     20 °C
Smoke:    3 1 2
Aver. n:   2
    
```

14.0 SENSORS

14.1 Sensors arrangement

SENSOR ARRANGEMENT INSIDE THE SENSOR COMPARTMENT

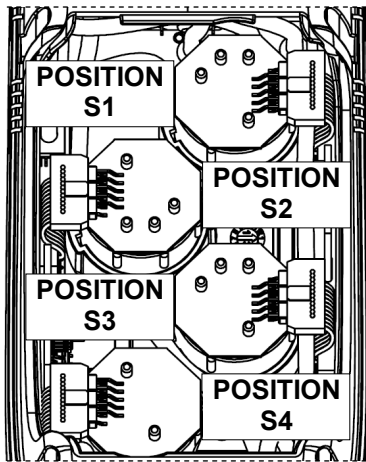

GRAPHICAL DISPLAY OF ARRANGEMENT

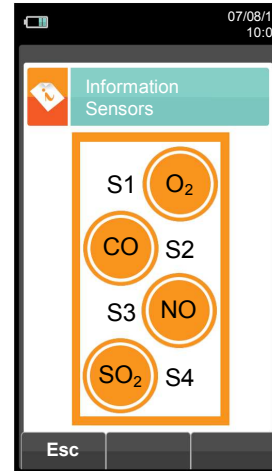

14.2 Sensor types and relevant positioning

CODE \ POSITION	S1	S2	S3	S4
Flex-Sensor O₂ Cod. AACSE11	✓			
Flex-Sensor O₂ Cod. AACSE15	✓			
Flex-Sensor CO+H₂ Cod. AACSE12		✓		
Flex-Sensor CO high (H₂ Comp) Cod. AACSE20		✓	✓	✓
Flex-Sensor NO Cod. AACSE10			✓	
Flex-Sensor NO₂ Cod. AACSE14		✓	✓	✓
Flex-Sensor SO₂ Cod. AACSE13		✓	✓	✓
Flex-Sensor CO 100,000 ppm Cod. AACSE17		✓	✓	✓
Flex-Sensor CO 20,000 ppm Cod. AACSE18		✓	✓	✓
FLEX-Sensor CxHy 0-5.00% vol. referred to CH₄ Cod. AACSE23				✓
Flex-Sensor CO+H₂ low range Cod. AACSE24		✓		
Flex-Sensor NO low range Cod. AACSE25			✓	
Flex-Sensor NO₂ low range Cod. AACSE26		✓	✓	✓
Flex-Sensor SO₂ low range Cod. AACSE28		✓	✓	✓
Flex-Sensor CO₂ Cod. AACSE29			✓	✓

14.3 Gas sensor life

The gas sensors used in this instrument are electrochemical: thus, when the relative gas is detected, a chemical reaction takes place inside them that generates an electrical current.

The electrical current acquired by the instrument is then converted into the corresponding gas concentration. Sensor life is strongly related to the consumption of the reagents within.

Sensor characteristics diminish as the reagents are consumed and when these have been used up completely the sensor must be replaced. The sensors must be recalibrated on a regular basis to assure measuring accuracy: recalibration can only be performed by a qualified E INSTRUMENTS service center. Chart 14.4 illustrates the characteristics inherent to each sensor.

14.4 Table gas sensors life

CODE	MEASURED GAS	IDENTIFYING COLOR ⁽¹⁾	AVERAGE LIFE	RECALIBRATION
Flex-Sensor O₂ Cod. AACSE11	O ₂ Oxygen	Yellow	24 months	not necessary
Flex-Sensor O₂ Cod. AACSE15	O ₂ Oxygen		>24 months	not necessary
Flex-Sensor CO+H₂ Cod. AACSE12	CO Carbon Monoxide	Red	48 months	Yearly ⁽²⁾
Flex-Sensor CO high (H₂ Comp) Cod. AACSE20	CO Carbon Monoxide		>36 months	Yearly ⁽²⁾
Flex-Sensor NO Cod. AACSE10	NO Nitrogen Oxide	Orange	48 months	Yearly ⁽²⁾
Flex-Sensor NO₂ Cod. AACSE14	NO ₂ Nitrogen Dioxide	White	36 months	Yearly ⁽²⁾
Flex-Sensor SO₂ Cod. AACSE13	SO ₂ Sulphur Dioxide	Green	36 months	Yearly ⁽²⁾
Flex-Sensor CO 100,000 ppm Cod. AACSE17	CO Carbon Monoxide	Purple	48 months	Yearly ⁽²⁾
Flex-Sensor CO 20,000 ppm Cod. AACSE18	CO Carbon Monoxide	Blue	48 months	Yearly ⁽²⁾
FLEX-Sensor C_xH_y 0-5.00% vol. referred to CH₄ Cod. AACSE23	C _x H _y Unburned Hydrocarbons		48 months	Yearly ⁽²⁾
Flex-Sensor sniffer Cod. AACSE19	Sniffer Methane / LPG		60 months	Yearly ⁽²⁾
Flex-Sensor CO+H₂ low range Cod. AACSE24	CO Carbon Monoxide	Red	48 months	Yearly ⁽²⁾
Flex-Sensor NO low range Cod. AACSE25	NO Nitrogen Oxide	Orange	48 months	Yearly ⁽²⁾
Flex-Sensor NO₂ low range Cod. AACSE26	NO ₂ Nitrogen Dioxide	White	48 months	Yearly ⁽²⁾
Flex-Sensor SO₂ low range Cod. AACSE28	SO ₂ Sulphur Dioxide	Green	48 months	Yearly ⁽²⁾
Flex-Sensor CO₂ Cod. AACSE29	CO ₂ Carbon Dioxide		>48 months	Yearly ⁽²⁾

Notes:

(1) Colored dot on the sensor electronic board.

(2) UNI 10389-1 standard requires for the instrument calibration once per year to be performed in a laboratory authorised to issue calibration certificates.

14.5 Expandability to 4 sensors

In the E4500 instruments range, two are the versions which can be expanded:

E4500-2

2 sensors, expandable to 3 or 4 sensors.

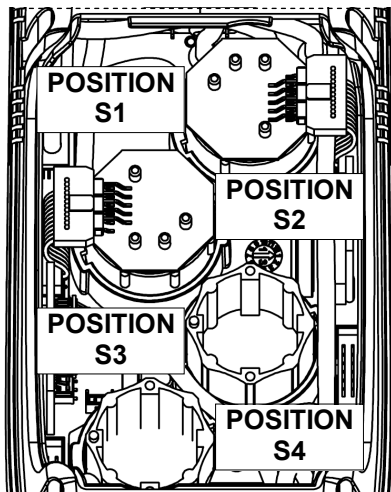

E4500-3

3 sensors, expandable to 4 sensors.

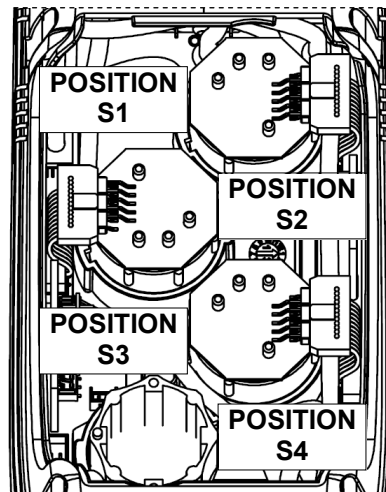

The upgrading of the number of sensors can be easily done by the user by performing the following directions:

- Both the expandable instruments are arranged in a way to accept one or two additional sensors in positions S3 and S4.
- Identify, with the help of paragraph 5.2 'Sensor types and relevant positioning' the sensor(s) which must be added to the existing configuration (E Instruments delivers all FLEX-series sensors already pre-calibrated and ready to use).
- To install the new sensors follow all the steps described in the paragraph 'MAINTENANCE' under 'gas sensors replacement'.



THE INSTRUMENT AUTOMATICALLY DETECTS WHEN AN ADDITIONAL SENSOR IS INSTALLED OR HAS BEEN REMOVED. THE SCREEN 'SENSORS CONFIGURATION' ALLOWS TO ACCEPT THE NEW PROPOSED CONFIGURATION OR TO IGNORE THE CHANGE DETECTED.

IN THIS SCREEN ARE SHOWN, FOR EACH POSITION, THE FOLLOWING MESSAGES:

EXAMPLE OF AN 'NO' SENSOR IN POSITION 3 REPLACED WITH AN 'NO2' SENSOR:

NO→NO₂ A SENSOR DIFFERENT FROM THE PREVIOUS ONE HAS BEEN DETECTED.

EXAMPLE OF A NEW SENSOR INSTALLED IN POSITION 4 (PREVIOUSLY NOT PRESENT):

SO₂→□ A NEW SENSOR HAS BEEN DETECTED.

14.6 CxHy sensor for measurement of the Unburned hydrocarbons

The Unburned hydrocarbons are chemicals produced by an incomplete combustion of molecules (hydrocarbons) made of Carbon and Hydrogen.

These are usually named as HC or (better) CxHy: when this is filled with the actual values for the number of C and H atoms, the actual type of fuel is exactly defined. In case of Methane, as an example, the correct formula is CH₄. In the following table is shown the cross sensitivity of the CxHy sensor when exposed to fuels different from Methane (CH₄), assumed as 1.00.

GAS / VAPOR	RELATIVE RESPONSE (with respect to Methane)	GAIN ADJUSTMENT
Ethanol	0.75	1.33
Iso-Butane	0.60	1.67
Methane	1.00	1.00
Methanol	1.00	1.00
n-Butane	0.60	1.67
n-Heptane	0.45	2.22
n-Hexane	0.50	2.00
Propane	0.70	1.43

Calculation example:

Type of gas: iso-butane
 Relative response: 0.6
 Gain adjustment: 1.67
 Reading value (related to methane): 1.34

Value = reading value x gain adjustment

Example: $1.34 \times 1.67 = 2.24$

14.7 Installing the CxHy sensor

When the CxHy (position S3/S4) is mounted in the instrument, it is mandatory to configure the autozero by setting it at 180 seconds, in order to allow for a proper pre-heating of the sensor itself.

The instrument battery life, once the CxHy is installed, lasts 10 hours, provided no printing is made.

Configuration → Analysis → Autozero (SEE SECTION 9.2.6)



14.8 CO₂ sensor for Carbon Dioxide measurement in combustion processes

Carbon Dioxide (CO₂) is the result of combustion of an organic compound in presence of a quantity of oxygen sufficient to complete its oxidation. In nature, it is also produced by aerobic bacteria during the process of alcoholic fermentation and is the by product of respiration.

Many combustion processes are defined with 'mixed fuel' and is therefore difficult to calculate the amount of CO₂ produced. To avoid this drawback, the only way to know the amount of CO₂ produced in a combustion process with 'mixed fuel' is to measure the CO₂ with special NDIR sensors.

14.9 Installing the CO₂ sensor

When the CO₂ (position S3/S4) is mounted in the E4500, it is mandatory to configure the autozero by setting it at 60 seconds, in order to allow for a proper pre-heating of the sensor itself.

Configuration → Analysis → Autozero (SEE SECTION 9.2.6)

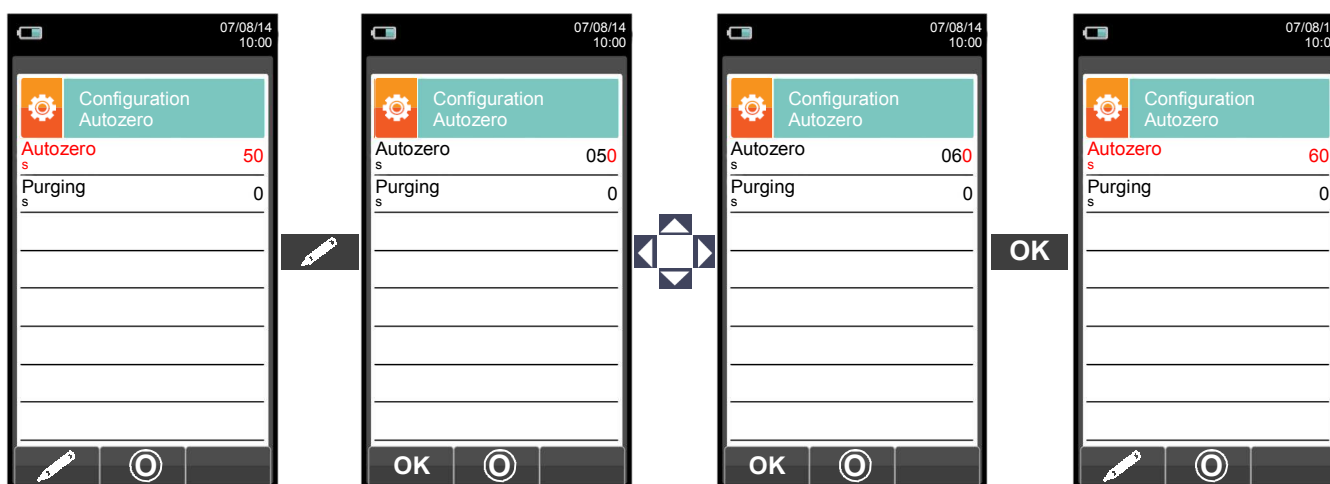

15.1 Routine maintenance

This instrument was designed and manufactured using top-quality components. Proper and systematic maintenance will prevent the onset of malfunctions and will increase instrument life altogether.

The following basic requisites are to be respected:

- Do not expose the instrument to substantial thermal shocks before use. If this happens, wait for the temperature to return to normal working values.
- Do not extract flue gas samples directly without using a particulate/water trap.
- Do not exceed sensor overload thresholds.
- When the analysis is over disconnect the sample probe and let the E4500 draw fresh air for a few minutes, or at least until the displayed parameters return to their original values. Do NOT bypass Post purge of the unit.
- Clean the filter unit when necessary, replacing the particulate filter and applying a jet of air to the sample probe hose to eliminate any condensate that may have formed.

Do not clean the instrument with abrasive cleaners, thinners or other similar detergents.

15.2 Preventive maintenance

At least once a year send the instrument to a SERVICE CENTER for a complete overhaul and thorough internal cleaning.

E INSTRUMENTS's highly qualified staff is always at your disposal and will provide you with all the sales, technical, application and maintenance details required.

The service center will always return the instrument to you as new and in the shortest time possible. Calibration is performed using gases and instruments comparable with National and International Specimens. Annual servicing is accompanied by a specific calibration certificate that is a guarantee of perfect instrument performance as required by UNI 10389-1, besides being indispensable for users wishing to maintain ISO 9000 status.

15.3 Cleaning the sample probe

When you finish using the sample probe clean it thoroughly as described below before returning it to its case:

- Disconnect the sample probe from the instrument and from the water trap (Fig. a-b) then blow a jet of clean air into the hose of the probe (refer to Fig. b) to remove any residual condensate that may have formed within.

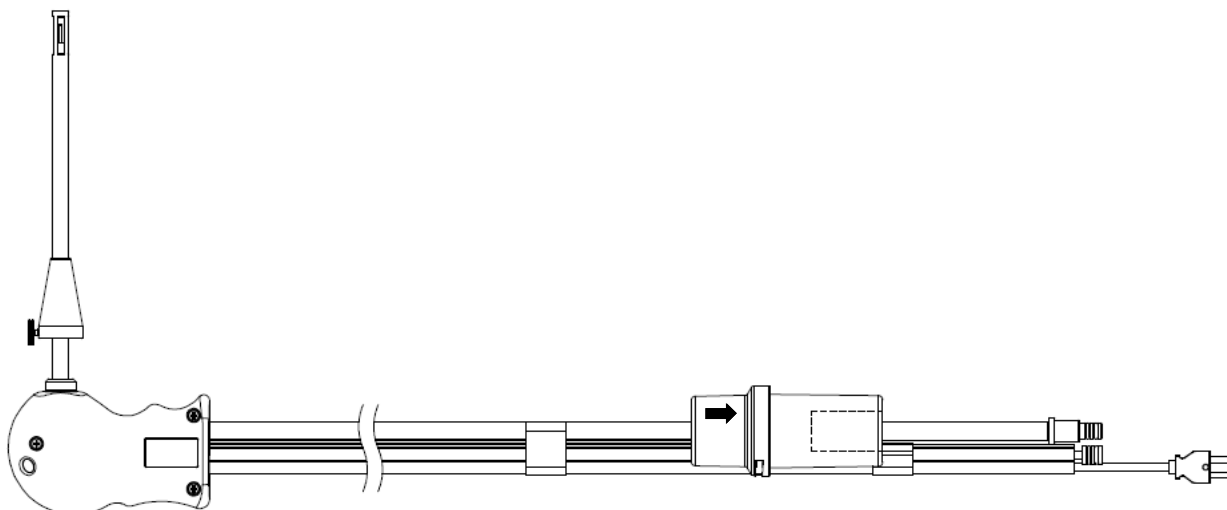

Fig. a

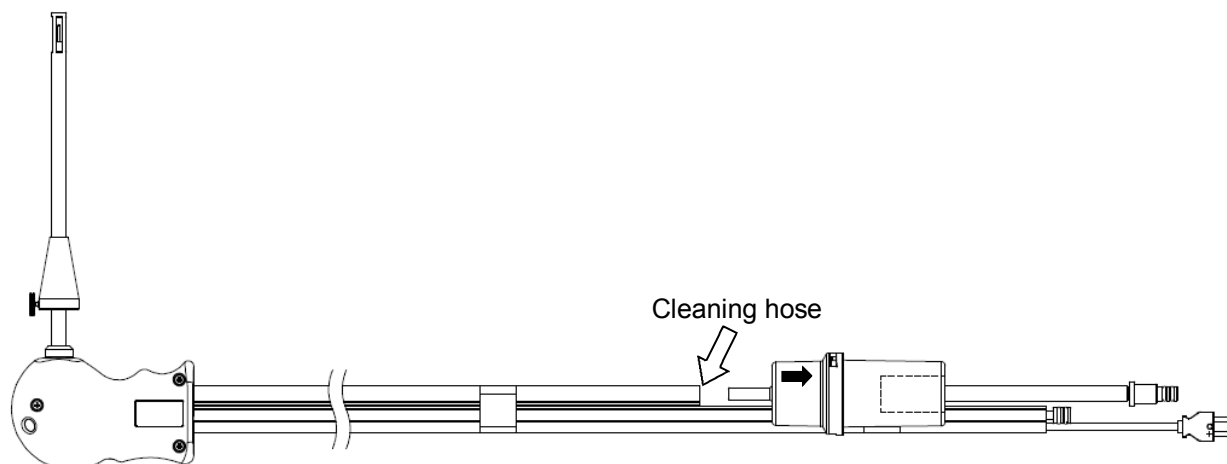
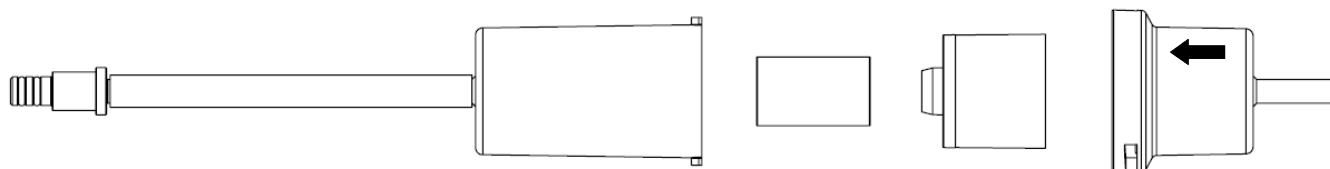

Fig. b

15.4 Maintaining the water trap / filter unit

To remove the water trap, just rotate the cover and unhook the filter holder body; remove the internal cup and then replace the filter (see figure on the side).

Clean all the filter parts using water only, dry the components and reassemble the filter.



15.5 Replacing the particulate filter

If the particulate filter appears black, especially on the inner surface (see adjacent example), it has to be replaced immediately. In this way gas flow is not obstructed.

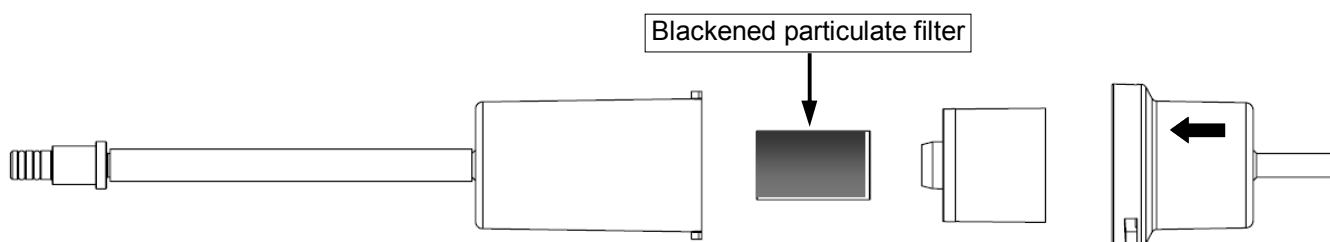

15.6 Replacing the gas sensors

The gas sensors of the instrument shall be periodically replaced (see the following table) with new or recalibrated sensors.

The user can easily perform this replacement operation according to the following instructions:

- 1 Undo the two fixing screws on the sensor compartment cover.
- 2 Extract the cover to have access to the sensor compartment.

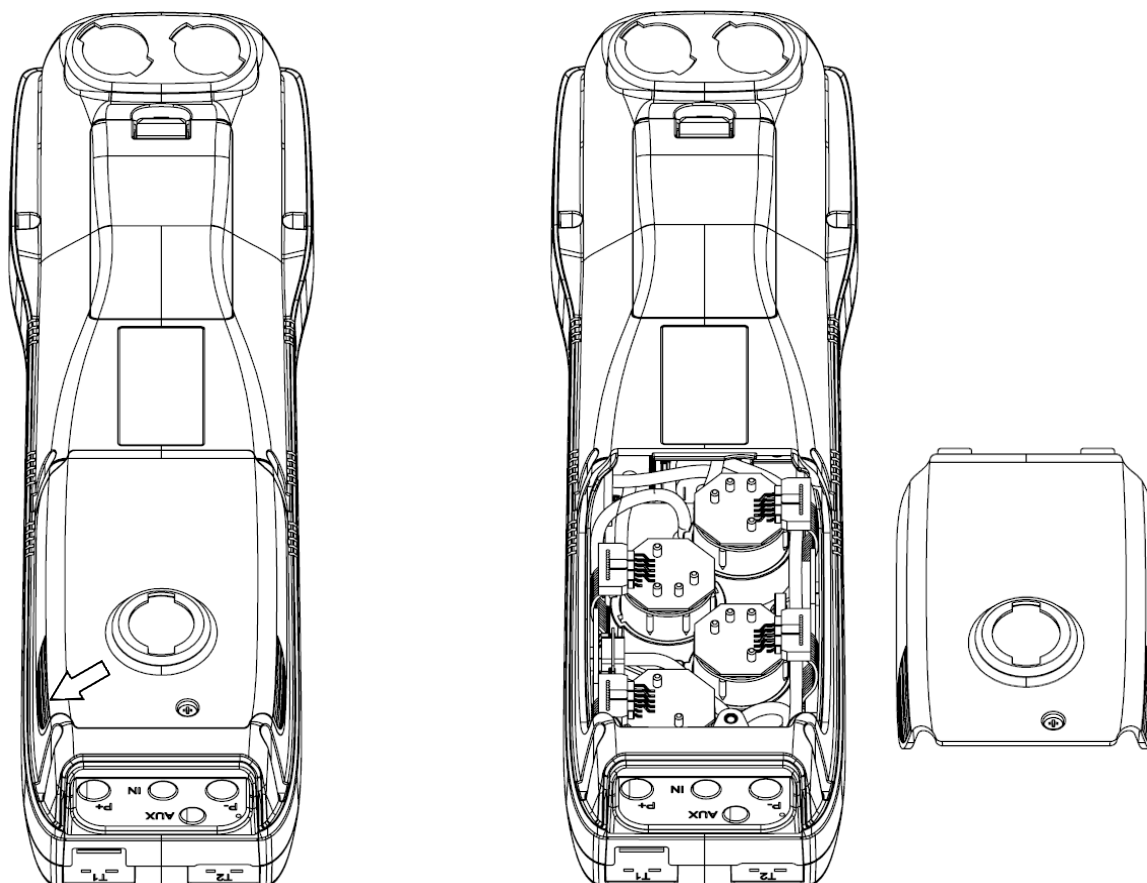

- 3 Locate the sensor to be replaced; here is an example of a connected sensor to be replaced.

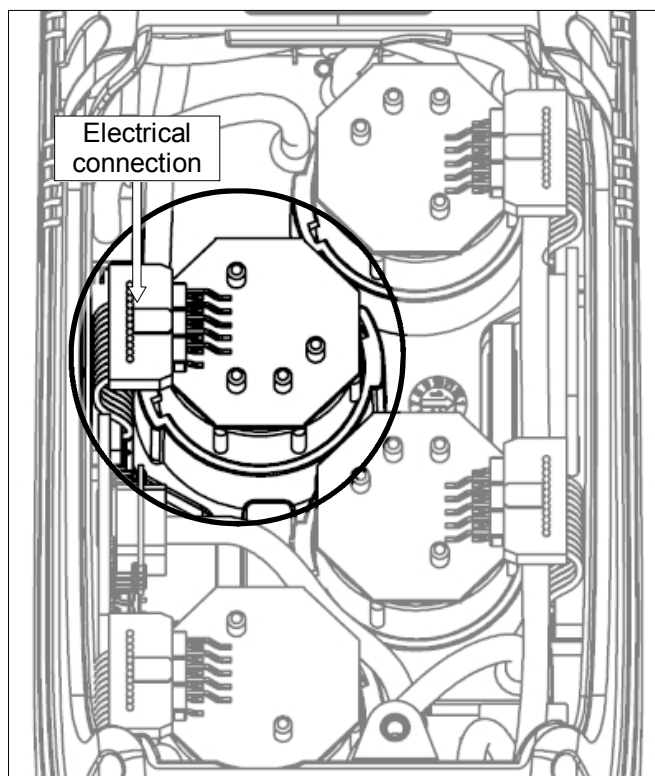

- 4 Disconnect the sensor to be replaced; here is an example of a disconnected sensor to be replaced.

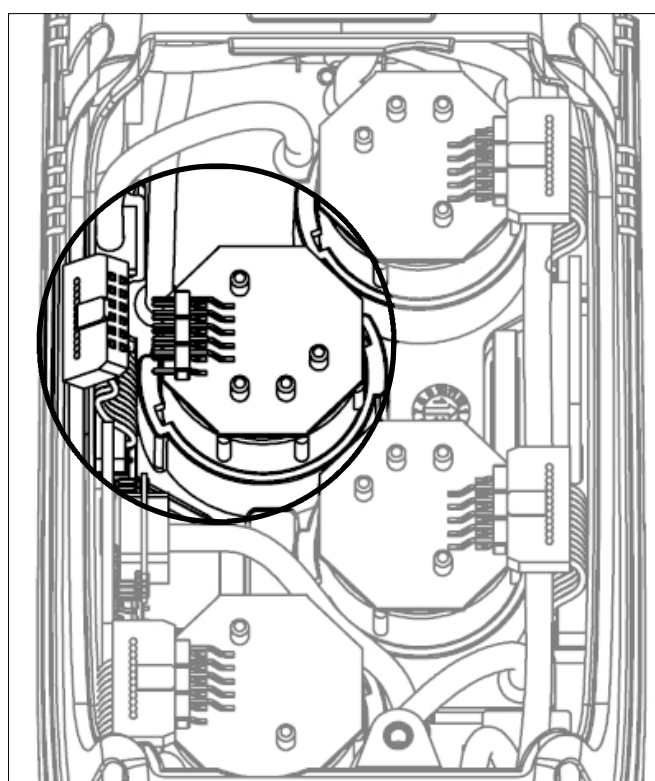

- 5 The sensor is bayonet-connected to its socket; rotate it counter-clockwise to remove it. Here is an example of a rotated sensor.



While rotating the sensor, take care not to exert any pressure onto the printed circuit above: exert pressure only onto the plastic body.

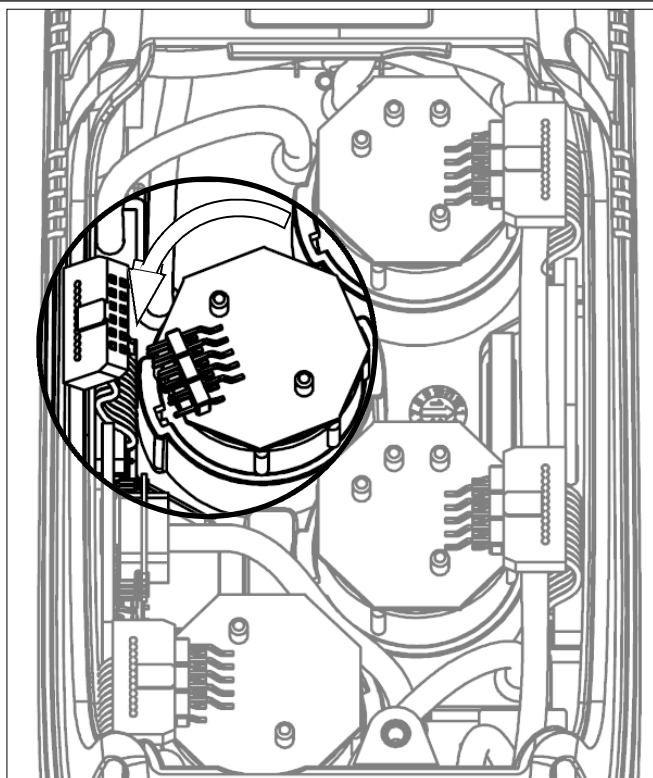

- 6 After rotating the sensor, pull it upward; here is an example of the sensor compartment with a sensor removed.

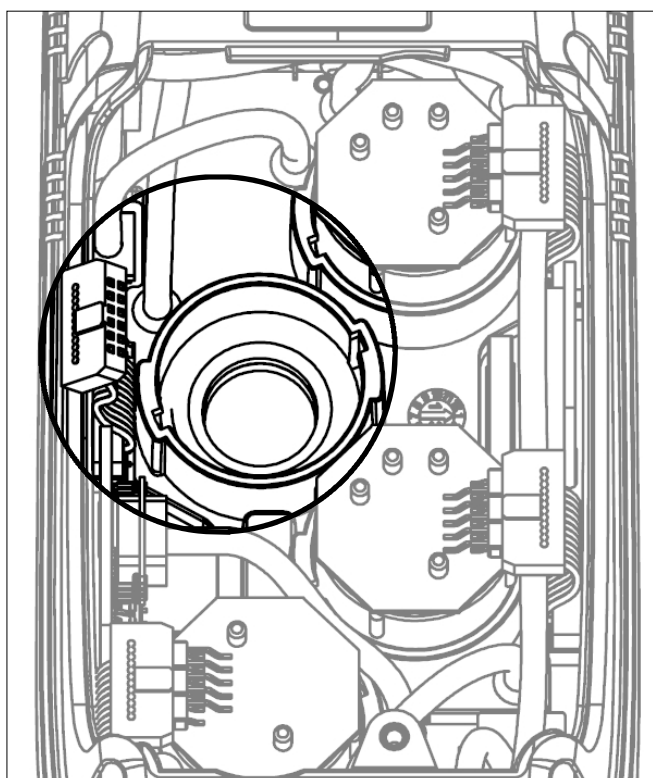

- 7 Fit the sensor again taking care the electric connection is turned outside the instrument, not inside (See point 5).

- 8 Rotate the sensor clockwise until hearing a click (See point 4).



While rotating the sensor, take care not to exert any pressure onto the printed circuit above: exert pressure onto the plastic body only.

- 9 Reconnect the sensor (See point 3).
 10 Close the back door of the sensor compartment again, and tighten screws again (See point 1).

Turn on the instrument to check the new sensor works correctly through the menu "Sensor Troubleshooting".
It is normal if a newly installed sensor gives a 'current error': it is necessary to wait some time, so that the sensor polarization can settle. The table here below shows the minimum settling time for each sensor.

CODICE	GAS RILEVATO	POSITION	TEMPO DI ASSESTAMENTO
Flex-Sensor O₂ Cod. AACSE11	O ₂ Oxygen	S1	2 hours ⁽¹⁾
Flex-Sensor O₂ Cod. AACSE15	O ₂ Oxygen	S1	2 hours ⁽¹⁾
Flex-Sensor CO+H₂ Cod. AACSE12	CO Carbon Monoxide	S2	2 hours ⁽¹⁾
Flex-Sensor CO high (H₂ Comp) Cod. AACSE20	CO Carbon Monoxide	S2/S3/S4	2 hours ⁽¹⁾
Flex-Sensor NO Cod. AACSE10	NO Nitrogen Oxide	S3	48 hours ⁽²⁾
Flex-Sensor NO₂ Cod. AACSE14	NO ₂ Nitrogen Dioxide	S2/S3/S4	2 hours ⁽¹⁾
Flex-Sensor SO₂ Cod. AACSE13	SO ₂ Sulphur Dioxide	S2/S3/S4	2 hours ⁽¹⁾
Flex-Sensor CO 100,000 ppm Cod. AACSE17	CO Carbon Monoxide	S2/S3/S4	2 hours ⁽¹⁾
Flex-Sensor CO 20,000 ppm Cod. AACSE18	CO Carbon Monoxide	S2/S3/S4	2 hours ⁽¹⁾
FLEX-Sensor CxHy 0-5.00% vol. referred to CH₄ Cod. AACSE23	CxHy Unburned hydrocarbons	S4	1/2 hour ⁽³⁾
Flex-Sensor CO+H₂ low range Cod. AACSE24	CO Carbon Monoxide	S2	2 hours ⁽¹⁾
Flex-Sensor NO low range Cod. AACSE25	NO Nitrogen Oxide	S3	48 hours ⁽²⁾
Flex-Sensor NO₂ low range Cod. AACSE26	NO ₂ Nitrogen Dioxide	S2/S3/S4	2 hours ⁽¹⁾
Flex-Sensor SO₂ low range Cod. AACSE28	SO ₂ Sulphur Dioxide	S2/S3/S4	2 hours ⁽¹⁾
Flex-Sensor CO₂ Cod. AACSE29	CO ₂ Carbon Dioxide	S3/S4	2 hours ⁽¹⁾

Note:

- (1) 2 hours' settling time is recommended.
 (2) 48 hours' settling time is recommended; should the sensor be equipped with an external polarization battery, the settling time is reduced down to 2 hours.
 (3) 1/2-Hour settling time is recommended.

15.7 Replacing the battery pack

Follow these instructions to replace the battery pack:

- 1** Remove the battery compartment cover.

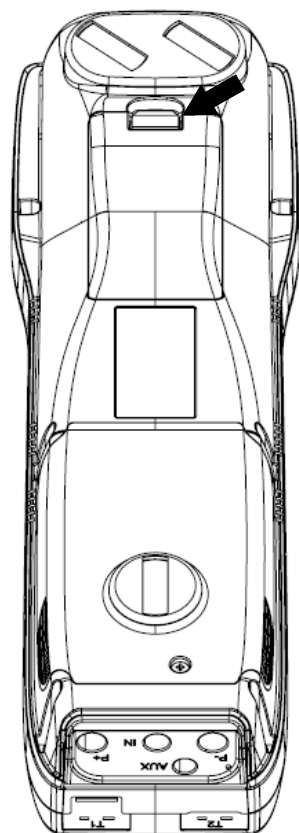

- 2** Extract the battery pack.

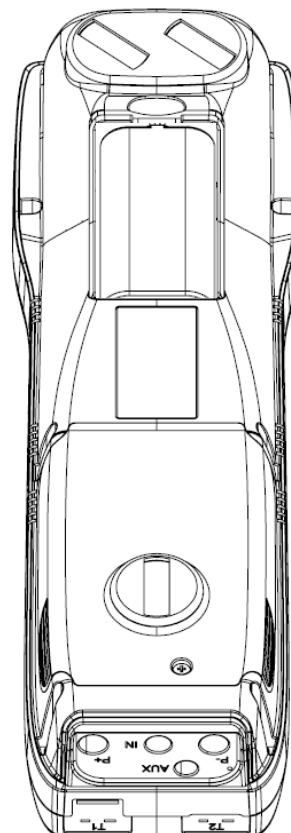

- 3** Remove the battery pack connector, and replace the pack with a new one following the reverse procedure described above.

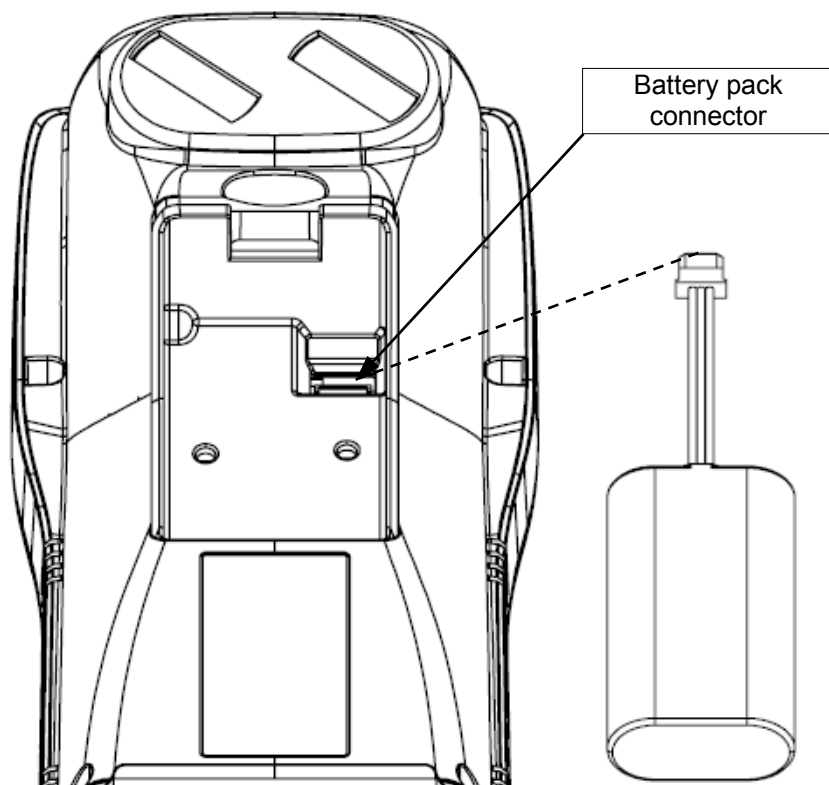

15.8 Replacing the printer paper

Follow these instructions to change the paper roll in the printer.

- 1** Lift the top tile, indicated by the arrow.

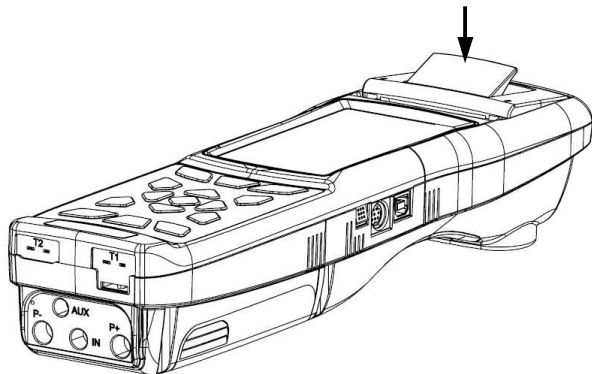

- 2** Lift the whole block of the lid completely.

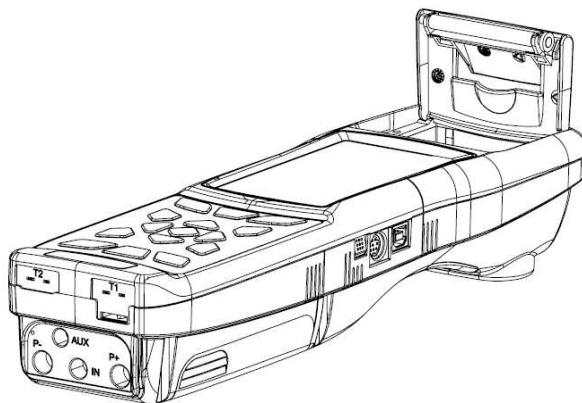

- 3** Insert the roll of printing paper as shown in the following figures.

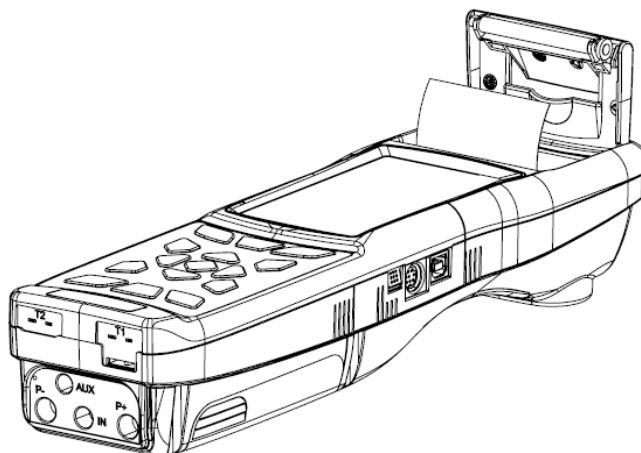
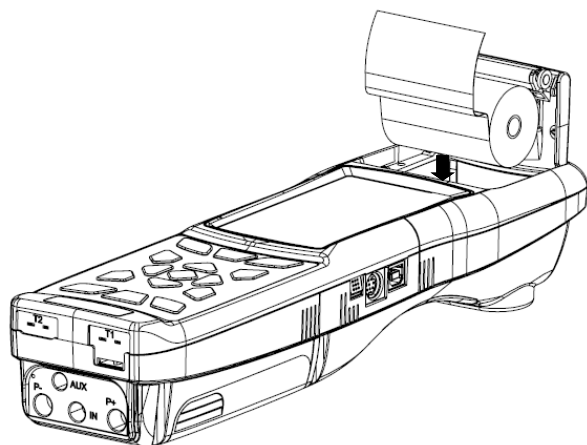

- 4** Close the whole block of the lid of the printer, pressing it lightly so as to hook it on to the device.

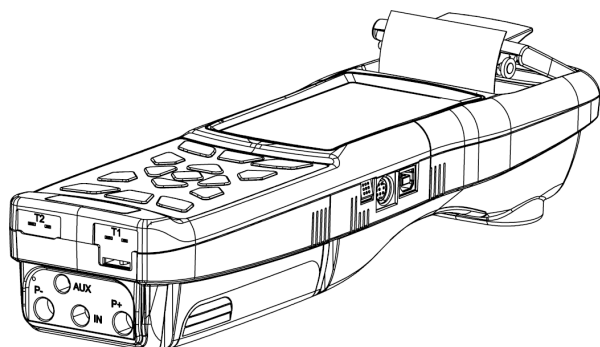

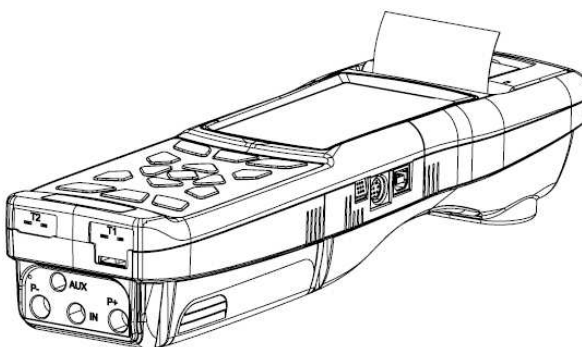

- 5** At this point it is possible to use the printer. See the parameter "Print".



16.0 TROUBLESHOOTING

16.1 Troubleshooting guide

SYMPTOM	PROBABLE CAUSES AND REMEDIES
The instrument does not work at all. When the On/Off pushbutton is pressed the instrument does not come on.	<ul style="list-style-type: none"> a. Keep the On/Off key depressed for at least 2 seconds. b. The battery is low; connect the battery charger to the instrument. c. The battery pack is not connected to the instrument; remove the cover from the battery compartment and connect the connector of the battery pack to the outlet on the printed circuit board. d. The instrument is faulty: send it to service center.
The battery symbol  is empty on the inside.	The batteries are low. The instrument will remain on for a couple of minutes after which it will switch off; connect the battery charger.
After auto-calibration is complete the sensor diagnostics screen appears and gives an error for one or more sensors.	<ul style="list-style-type: none"> a. Auto-calibration took place while the flue gas was being sampled. b. The O₂ sensor is faulty, is not connected correctly or is not connected at all. Check the above points, also referring to sections 5.3, 5.4, 6.6. c. The sensor was not allowed the necessary adjustment time or the instrument was left with a low battery for too long.
A pressure sensor error is shown in the pressure/draft screen.	There is a calibration problem. Send the instrument to a service center.
The analysis screen gives a flue gas temperature (Tf) error.	<ul style="list-style-type: none"> a. The thermocouple is not connected; connect the thermocouple to the analyzer. b. The sensor has been exposed to temperatures greater or lower than its operating temperature range. c. The thermocouple is faulty. Send the complete probe to a service center.
The following symbol "----" appears on the analysis screen.	The instrument is not able to calculate a numerical value based on the flue gas analysis conducted. The "----" are replaced by numbers when the analyzer detects valid combustion data.
"Max. Lim." or "Min. Lim" appears on the analysis screen.	The relative sensor is detecting a value that is beyond the analyzer's measuring range. "Max. Lim" or "Min. Lim." are replaced by numbers when the instrument reveals values that are within the measuring range.
The sample pump sounds as though it is running slowly, tends to stop or does not even start.	<ul style="list-style-type: none"> a. Sample flow is obstructed. Check that the water filter is clean and that it is not completely soaked. Also check that the hose connected to the probe is not crushed. b. Sample intake flow is obstructed. Check that the particulate filter is clean. c. The pump is not connected as it should be. Remove the rear flap and check that the pump's electrical connector is connected to the printed circuit board. d. Pump is faulty. Replace the pump unit. e. Pump is disabled. The key combination   has been pressed. To re-enable the pump, switch off the instrument and then switch it on again.

Troubleshooting guide

SYMPTOM	PROBABLE CAUSES AND REMEDIES
The rear lighting of the display is not on.	The backlighting LED's are faulty. Contact the nearest service center to replace the display.
The batteries last less than 9 hours.	<p>a. Battery capacity is limited by low temperatures. To achieve a longer battery life it is recommended to store the instrument at higher temperatures.</p> <p>b. The battery pack is old. Battery capacity tends to diminish with age. If battery life has become unacceptable, replace the battery pack:</p>
The values shown in the analysis screen are not reliable.	<p>a. Sensor/s is/are faulty. Check that the sensors are installed correctly by accessing the sensor diagnostics menu.</p> <p>b. The sample probe connection presents a leak. Check all joints and the conditions of the hose.</p> <p>c. Pump is faulty. Replace the pump unit.</p> <p>d. The instrument is faulty: Send it to a service center for repair.</p>
During the tightness test a "sensor error" is reported.	Check for the correct connection of the hose to the positive pressure input.

17.1 Spare parts

AAC BF01:	Sensor junction block
AAC FA01:	Particulate filter
AAC PB06:	Li-Ion 7.2V 2.4Ah battery pack
AA RC05:	Paper roll for printer, h=57mm Diam.=40mm
AAC ADX 005:	Dummy sensor
AAC SE11:	FLEX-Sensor O ₂ , pre-calibrated and interchangeable
AAC SE12:	FLEX-Sensor CO+H ₂ , pre-calibrated and interchangeable
AAC SE10:	FLEX-Sensor NO/NO _x , pre-calibrated and interchangeable
AAC SE14:	FLEX-Sensor NO ₂ , pre-calibrated and interchangeable
AAC SE13:	FLEX-Sensor SO ₂ , pre-calibrated and interchangeable
AAC SE15:	FLEX-Sensor O ₂ , pre-calibrated and interchangeable
AAC SE17:	FLEX-Sensor CO 100,000 ppm, pre-calibrated and interchangeable
AAC SE18:	FLEX-Sensor CO 20,000 ppm, pre-calibrated and interchangeable
AAC SE19:	FLEX-Sensor sniffer, pre-calibrated and interchangeable
AAC SE20:	FLEX-Sensor CO high immunity H ₂ , pre-calibrated and interchangeable
AAC SE33:	FLEX-Sensor CxHy related to CH ₄ , pre-calibrated and interchangeable
AAC SE24:	FLEX-Sensor CO+H ₂ low range, pre-calibrated and interchangeable
AAC SE25:	FLEX-Sensor NO low range, pre-calibrated and interchangeable
AAC SE26:	FLEX-Sensor NO ₂ low range, pre-calibrated and interchangeable
AAC SE28:	FLEX-Sensor SO ₂ low range, pre-calibrated and interchangeable
AAC SE29:	FLEX-Sensor CO ₂ , pre-calibrated and interchangeable

17.2 Accessories

AA AL05:	100-240V~/12 VDC 2A feeder with 2 m cable
AA CA02:	Power supply with car adapter
AA CR07:	Rigid plastic case
AA ZN01:	Back-pack
AAC CT01:	Case with shoulder strap
AAC DP02:	Deprimometer for Draft test
AAC KP01:	Differential pressure kit
AA KT04:	Tightness test kit
AA PM02:	Manual pump kit for smoke measurement
AA SA08:	200 mm air temperature probe (cable length 2 mt)
AA SF61A:	7" (180 mm) gas probe, 2012°F (1100°C) extended temperature range, with 3 mt cable
AA SF51A:	7" (180 mm) gas probe, 2012°F (1100°C) extended temperature range, with 2 mt cable
AA SF62A:	12" (300 mm) gas probe, 2012°F (1100°C) extended temperature range, with 3 mt cable
AA SF52A:	12" (300 mm) gas probe, 2012°F (1100°C) extended temperature range, with 2 mt cable
40HT:	40" (1000 mm) gas probe, 2190°F (1200°C) extended temperature range, with 3 mt cable
60HT:	60" (1525 mm) gas probe, 2190°F (1200°C) extended temperature range, with 3 mt cable
AA SX01:	Gas sampling probe for average CO, 300mm with 2 m cable
AA SX02:	Probe for industrial motors, 400mm with 3 m cable
AA SL05A:	220 mm. flexible gas probe, 1100°C extended temperature range, with 2 mt cable
AA SP01:	Protective screen for gas sampling probe
AAC EX02S:	10' (3 m) extension cable for gas sampling probe
AA SM06:	Rubber protecting cover
AAC SO01:	Probe for measuring the ionisation current
AA SW08:	Configuration software kit (USB + PC cable)
AAC TA03:	Particulate/water filter assembly
AAC TA03A:	Particulate/water filter assembly with steel pipe and connector
AA UA03:	Adapter cable USB-A / mini USB-B

17.3 Service Center

E Instruments International LLC
402 Middletown Blvd, Suite 216
Langhorne, PA 19047 (USA)
Tel.: (215) 750-1212
Fax.: (215) 750-1399
E-mail: info@E-Inst.com
<http://www.E-Inst.com>

Example of Total analysis report.

COMPANY Ltd.
 Park Road, 9
 Tel.800-555-1234

Oper.: John Smith
 Sign.: _____

Test according to
 UNI 10389-1

E4500-3
 Serial: 999989
 Memory: 01
 Analysis: Average
 Date: 04/04/14
 Time: 10.30

Fuel: Natural gas
 Altitude: 0 m
 R.H. air: 50 %

MEASURED VALUES

T flue	191.1 °C
T air	15.4 °C
O2	4.2 %
CO	146 ppm
NO	40 ppm
CO amb	0 ppm
Draft:	0.05 hPa

CALCULATED VALUES

Ex. Air	1.25
CO2	9.3 %
Loss tot	8.6 %
Eff. tot	98.5 %
ηc	4.9 %
ηt	103.4 %
ΔT	174.7 %
NOx/NO:	1.03
NOx	41 ppm
Ref. O2:	0.0 %
CO	182 ppm
Ref. O2:	0.0 %
NO	50 ppm
Ref. O2:	0.0 %
NOx	51 ppm

Note: -----

Analysis: 1
 04/04/14 10.00

O2	4.2 %
CO2	9.3 %
Ex. Air	1.25
T flue	190.2 °C
T air	15.4 °C
ΔT	174.8 °C
Loss tot	8.6 %
Eff. tot	91.4 %
ηc	4.9 %
ηt	91.4 %
CO	148 ppm
NO	40 ppm
NOx/NO:	1.03
NOx	41 ppm

Analysis: 2
 04/04/14 10.15

O2	4.4 %
CO2	9.2 %
Ex. Air	1.26
T flue	190.2 °C
T air	15.4 °C
ΔT	174.6 °C
Loss tot	8.7 %
Eff. tot	91.4 %
ηc	4.9 %
ηt	91.4 %
CO	145 ppm
NO	40 ppm
NOx/NO:	1.03
NOx	41 ppm

Analysis: 3
 04/04/14 10.20

O2	4.2 %
CO2	9.3 %
Ex. Air	1.25
T flue	190.1 °C
T air	15.4 °C
ΔT	174.7 °C
Loss tot	8.7 %
Eff. tot	91.4 %
ηc	4.9 %
ηt	91.4 %
CO	146 ppm
NO	40 ppm
NOx/NO:	1.03
NOx	41 ppm

Example of Full analysis report.

COMPANY Ltd.
 Park Road, 9
 Tel.800-555-1234

Oper.: John Smith

Sign.: _____

Test according to
 UNI 10389-1

E4500-3
 Serial: 999989
 Memory: 01
 Analysis: Average
 Date: 04/04/14
 Time: 10.30

Fuel: Natural gas
 Altitude: 0 m
 R.H. air: 50 %

MEASURED VALUES

T flue	191.1 °C
T air	15.4 °C
O2	4.2 %
CO	146 ppm
NO	40 ppm
CO amb	0 ppm
Draft:	0.05 hPa

CALCULATED VALUES

Ex. Air	1.25
CO2	9.3 %
Loss tot	8.7 %
Eff. tot	91.4 %
ηc	4.9 %
ηt	103.4 %
ΔT	174.7 %
NOx/NO:	1.03
NOx	41 ppm
Ref. O2:	0.0 %
CO	182 ppm
Ref. O2:	0.0 %
NO	50 ppm
Ref. O2:	0.0 %
NOx	51 ppm

Note:-----

Example of Partial Ticket.

Date: 04/04/14
 Time: 10.15

Fuel: Natural gas
 Altitude: 0 m
 R.H. air: 50 %

O2	4.2 %
CO2	9.3 %
Ex. Air	1.25
T flue	190.2 °C
T air	15.4 °C
ΔT	174.8 °C
Loss tot	8.7 %
Eff. tot	91.4 %
ET	4.9 %
ηt	91.4 %
CO	148 ppm
NO	40 ppm
NOX/NO:	1.03
NOX	41 ppm
CO amb	0 ppm
Draft:	0.05 hPa

Smoke: 3 1 2
 Aver. n°: 2

Example of tightness test report ticket.

COMPANY Ltd.
Park Road, 9
Tel.800-555-1234

Oper.: John Smith

Sign.: _____

Test according to
UNI 11137: 2012 standard
Indirect method

E4500-3
Serial: 999989
Memory: 01

Date: 04/04/14
Time: 10.30

Stab. duration: 1 min
Test duration: 1 min

Comb. Gas: Methane
Test gas: Air

Vimp	25.0 dm ³
P1	10.05 hPa
P2	10.03 hPa
ΔP	-0.02 hPa
Qtest	0.0 dm ³ /h
Qref	0.0 dm ³ /h

Result: compliant

Note: -----

Example of ambient CO Ticket.

COMPANY Ltd.
Park Road, 9
Tel.800-555-1234

Oper.: John Smith

Sign.: _____

E4500-3
Serial: 999989
Memory: 01

Date: 04/04/14
Time: 10.30

CO amb 0 ppm

Note: -----

Example of Draft Ticket.

COMPANY Ltd.
Park Road, 9
Tel.800-555-1234

Oper.: John Smith

Sign.: _____

E4500-3
Serial: 999989
Memory: 01

Date: 04/04/14
Time: 10.30

Draft: 0.05 inH2O

Note: -----

Example of Smoke Ticket.

COMPANY Ltd.
Park Road, 9
Tel.800-555-1234

Oper.: John Smith

Sign.: _____

E4500-3
Serial: 999989
Memory: 01

Date: 04/04/14
Time: 10.30

Fuel: Diesel

Smoke: 3 1 2
Aver. n°: 2

Note: -----

Coefficients of the fuels and Formulas

The following chart, derived from standard UNI 10389-1, lists the coefficients of the memorized fuels, used for calculating losses and efficiencies.

Coefficients for calculating combustion efficiency								
Fuel	A1	B	CO ₂ t (%)	PCI (KJ/Kg)	PCS (KJ/Kg)	M aria (Kg/Kg)	M H ₂ O (Kg/Kg)	V gas dry (m ³ /Kg)
Natural gas	0.660	0.0100	11.70	50050	55550	17.17	2.250	11.94
Propane	0.630	0.0080	13.90	45950	49950	15.61	1.638	11.11
L.P.G.	0.630	0.0080	13.90	45730	49650	15.52	1.602	11.03
Butane	0.630	0.0080	13.90	45360	49150	15.38	1.548	10.99
Diesel oil	0.680	0.0070	15.10	42700	45500	14.22	1.143	10.34
Fuel oil	0.680	0.0070	15.70	41300	43720	13.73	0.990	10.06
Propane air	0.682	0.0069	13.76	28250	30700	9.13	0.999	6.77
Biogas	0.719	0.0086	16.81	19200	21250	6.38	0.840	5.82
Pellets 8%	0.740	0.0071	19.01	18150	19750	6.02	0.660	4.58
Wood 20%	0.761	0.0089	18.93	15450	17170	5.27	0.700	4.01
Chipped wood	0.8020	0.0108	20.56	11950	13565	4.20	0.660	3.25
Coal	0.7620	0.0023	19.06	31400	32300	10.70	0.370	8.14

Details of the coefficients of the fuels:

- **CO₂ t:** The value of CO₂ generated by combustion in stoichiometric condition, i.e. without excess Oxygen and therefore maximum.
- **A1, A2, B:** Also please have a look at the Siegert formulas from the European standard EN50379-1 (in the following).
A1 is the parameter in the Siegert Formula when the CO₂ measurement is available.
A2 is used when the O₂ measurement is available.
Note: Please also consider that in the U.S. usually the A1 parameter is the same as the 'european' A1 BUT divided by 21.

Flue gas heat losses are calculated from measured oxygen content according to the relationship:

$$q_A = (t_A - t_L) \times \left(\frac{A2}{21 - O_2} + B \right)$$

Flue gas heat losses are calculated from measured carbon dioxide content according to the relationship:

$$q_A = (t_A - t_L) \times \left(\frac{A1}{CO_2} + B \right)$$

- **CO conv:** Conversion coefficient from ppm to mg/KWh. It can be expressed as a function of the gas density (CO in this case) and the volume of the dry smoke.
- **NO conv:** Same as CO conv, but for NO.
- **NO_x conv:** Same as CO conv, but for NO.
- **SO₂ conv:** Same as CO conv, but for NO.
- **PCI:** Calorific Value. Italian for LHV (Lower Heating Value).
- **PCS:** Calorific Value. Italian for HHV (Higher Heating Value).
- **m H₂O:** Mass of the air produced (per each Kg of fuel) in the combustion in stoichiometric condition.
- **m Air:** Mass of the air needed for combustion in stoichiometric condition.
- **V g.d.:** Volume of dry smokes produced in the combustion.

DECLARATION OF CONFORMITY

The manufacturer: E Instruments International LLC

with registered address in: E Instruments International LLC
402 Middletown Blvd, Suite 216
Langhorne, PA 19047 USA

declares that the following products: 1500
E4500-2
E4500-3
E4500-N
E4500-S
E4500-C

is in conformity with the essential requirements of directives 2004/108/CE and 2006/95/CE. The full text of the conformity certificate with EMC directives (Electro-Magnetic Compatibility) and LVD directives (Electric Safety) is available, on request, from the manufacturer.

The instrument is in conformity with the requirements of the European standards EN 50379-1 and EN 50379-2 for the following measurements:

O₂
CO medium
NO
Temperature (flue gas)
Temperature (supply air)
Pressure (draft)
Pressure (differential)

NOTE

NOTE



E INSTRUMENTS INTERNATIONAL LLC

Address: 402 Middletown Blvd, Ste 216
Langhorne, PA 19047
USA

Tel.: (215) 750-1212

Fax: (215) 750-1399

E-mail: info@E-Inst.com

Website: www.E-Inst.com